

LC2412

EUROLIGHT

User's Manual

Version 1.1 May 2004

ENGLISH



EUROLIGHT LC2412

IMPORTANT SAFETY INSTRUCTIONS



CAUTION: To reduce the risk of electric shock, do not remove the top cover (or the rear section). No user serviceable parts inside; refer servicing to qualified personnel.

WARNING: To reduce the risk of fire or electric shock, do not expose this appliance to rain and moisture. The apparatus shall not be exposed to dripping or splashing and no objects filled with liquids, such as vases, shall be placed on the apparatus.



This symbol, wherever it appears, alerts you to the presence of uninsulated dangerous voltage inside the enclosure—voltage that may be sufficient to constitute a risk of shock.



This symbol, wherever it appears, alerts you to important operating and maintenance instructions in the accompanying literature. Please read the manual.

DETAILED SAFETY INSTRUCTIONS:

- 1) Read these instructions.
- 2) Keep these instructions.
- 3) Heed all warnings.
- 4) Follow all instructions.
- 5) Do not use this apparatus near water.
- 6) Clean only with dry cloth.
- 7) Do not block any ventilation openings. Install in accordance with the manufacturer's instructions.
- 8) Do not install near any heat sources such as radiators, heat registers, stoves, or other apparatus (including amplifiers) that produce heat.
- 9) Do not defeat the safety purpose of the polarized or grounding-type plug. A polarized plug has two blades with one wider than the other. A grounding type plug has two blades and a third grounding prong. The wide blade or the third prong are provided for your safety. If the provided plug does not fit into your outlet, consult an electrician for replacement of the obsolete outlet.
- 10) Protect the power cord from being walked on or pinched particularly at plugs, convenience receptacles, and the point where they exit from the apparatus.
- 11) Only use attachments/accessories specified by the manufacturer.
- 12) Use only with the cart, stand, tripod, bracket, or table specified by the manufacturer, or sold with the apparatus. When a cart is used, use caution when moving the cart/apparatus combination to avoid injury from tip-over.



- 13) Unplug this apparatus during lightning storms or when unused for long periods of time.
- 14) Refer all servicing to qualified service personnel. Servicing is required when the apparatus has been damaged in any way, such as power supply cord or plug is damaged, liquid has been spilled or objects have fallen into the apparatus, the apparatus has been exposed to rain or moisture, does not operate normally, or has been dropped.
- 15) **CAUTION** - These service instructions are for use by qualified service personnel only. To reduce the risk of electric shock do not perform any servicing other than that contained in the operation instructions unless you are qualified to do so.

CAUTION: DANGER OF EXPLOSION IF BATTERY IS INCORRECTLY REPLACED. REPLACE ONLY WITH IDENTICAL OR EQUIVALENT TYPE.

EUROLIGHT

Professional 24-channel DMX lighting console

- ▲ 24 preset channels, assignable to 512 DMX channels
- ▲ Up to 3 DMX channels can be controlled per preset channel
- ▲ 120 scenes storable in 10 banks
- ▲ Integrated chaser with up to 650 steps featuring sync-to-bass beat
- ▲ Frequency-dependent sound-to-light function
- ▲ Crossfade time freely selectable for super-smooth scene fades
- ▲ Two additional, multi-functional channels for special effects (e.g. fog machine, color changer)
- ▲ Ultra-flexible fading functions for manual and automatic operation
- ▲ Intuitive solo & channel flash functions
- ▲ Extremely effective preview function allows "hidden" memory and chaser checks even during live performances
- ▲ Dimmer control via DMX or analog output (0/+10 V)
- ▲ MIDI interface for cascading of two LC2412s (master/slave setup)
- ▲ PCMCIA card slot for storing of up to 25 complete settings (PCMCIA card not supplied)
- ▲ Illuminated display/controls and BNC lamp socket for easy operation in dark stage environments
- ▲ Extremely rugged steel construction ensures long life even under the most demanding conditions
- ▲ Rack-mounting kit for installation in standard 19" racks included
- ▲ Conceived and designed by BEHRNIGER Germany. Made in China.

FOREWORD



Dear Customer,

welcome to the team of BEHRINGER users, and thank you very much for expressing your confidence in us by purchasing the EUROLIGHT LC2412.

Writing this foreword for you gives me great pleasure, because it represents the culmination of many months of hard work delivered by our engineering team to achieve a very ambitious goal: to present an outstanding light mixing console that offers plenty of features

and on which you can rely even under the most demanding conditions. The task of designing our new LC2412 certainly meant a great deal of responsibility, which we assumed by focusing on you, the discerning user and musician. Meeting your expectations also meant a lot of work and night shifts. But it was fun, too. Developing a product usually brings a lot of people together, and what a great feeling it is when all who participated in such a project can be proud of what they've achieved.

It is our philosophy to share our enjoyment with you, because you are the most important member of the BEHRINGER team. With your highly competent suggestions for new products you've made a significant contribution to shaping our company and making it successful. In return, we guarantee you uncompromising quality as well as excellent technical and audio properties at an extremely reasonable price. All of this will enable you to give free rein to your creativity without being hampered by budget constraints.

We are often asked how we manage to produce such high-quality devices at such unbelievably low prices. The answer is quite simple: it's you, our customers! Many satisfied customers mean large sales volumes enabling us to get better purchasing terms for components, etc. Isn't it only fair to pass this benefit on to you? Because we know that your success is our success too!

I would like to thank all of you who have made the LC2412 possible. You have all made your own personal contributions, from the developers to the many other employees at this company, and to you, the BEHRINGER user.

My friends, it's been worth the effort!

Thank you very much,

Uli Behringer

TABLE OF CONTENTS

IMPORTANT SAFETY INSTRUCTIONS	2
EUROLIGHT	3
FOREWORD	4
1. INTRODUCTION	5
1.1 Before you get started	5
1.1.1 Shipment	5
1.1.2 Initial operation	5
1.1.3 Warranty	5
1.2 The user's manual	5
1.3 General features and functions	5
2. CONTROL ELEMENTS	6
2.1 Control elements of the A PRESET section [1]	7
2.2 Control elements of the B MEMORY section [2]	7
2.3 Control elements of the Sound-to-light section [3]	8
2.4 Section [4]: FLASH keys and SOLO	8
2.4.1 Disabling the solo function	8
2.5 Control elements of the programming section [5]	9
2.6 Control elements of the main section [6]	9
2.7 Control elements of the chase section [7]	10
2.8 Rear panel connectors of the LC2412	10
3. PRESETS	11
3.1 Basic configuration	11
3.1.1 Preset mode	11
3.2 Expanding to 24 preset channels (upper mode)	11
3.3 Crossfading between presets	11
4. THE B MEMORY SECTION	12
4.1 Programming, recalling and altering memories (scenes)	12
4.1.1 Programming	12
4.1.2 Fading in scenes	12
4.1.3 Previewing and modifying memories	12
4.2 Crossfading between different setups	12
4.2.1 Crossfading between presets and memories	12
4.2.2 Crossfading between memories	13
4.2.3 Crossfading between memories of different banks	13
4.3 Preset flash and memory flash	13
4.3.1 Preset flash	13
4.3.2 Memory flash	13
4.4 Programming memories without direct control (blind)	13
4.5 Previewing memories individually on the stage (live mode)	14
4.6 Additional application of memories	14
5. SOUND-TO-LIGHT	14
6. CHASE CONTROL	14
6.1 Programming or erasing chases	14
6.1.1 Programming level chase	14
6.1.2 Programming memory chase	14
6.1.3 Erasing chases	15
6.2 Running and pausing chases	15
6.2.1 Chase control through music	15
6.2.2 Chase control by means of SPEED fader (RUN)	15
6.2.3 Crossfading manually using the X-FADE fader (manual mode)	15
6.2.4 Manual fades using the STEP key [53]	15
6.2.5 Replacing memory steps	16
6.2.6 Inserting memory steps	16
6.3 Saving chases as memories (chase to memory)	16
6.3.1 Replaying chases stored as memories (CTM)	16
6.3.2 Previewing and editing CTM	16
6.4 Previewing chases in live mode	17

7. ADDITIONAL FUNCTIONS OF THE LC2412	17
7.1 Locking program mode	17
7.2 Putting the output on hold	17
7.3 Special channels	17
7.4 Theater mode	17
7.4.1 Activating theater mode	17
7.4.2 Programming fading times in theater mode	18
7.5 MIDI functions	18
7.5.1 Cascading two EUROLIGHT LC2412s	18
7.6 Storing data on a memory card	18
7.7 Adjusting differing illumination levels	19
7.8 Erasing all settings/displaying software version	19
8. DIMMER CONTROL	19
8.1 Analog control	19
8.1.1 Controlling analog dimmers via DMX512	19
8.2 Digital control via DMX512	19
8.2.1 Digital control features	19
8.2.2 Assigning DMX channels (softpatch)	20
9. INSTALLATION	20
9.1 Cables recommended for DMX512	21
9.2 Terminal resistor (bus termination)	21
9.3 Pin assignment	21
9.3.1 DMX512 connections	21
9.3.2 Sub D connections (analog control)	21
9.3.3 MIDI connection	21
9.3.4 Audio connections	21
9.3.5 Footswitch	21
9.4 Rack mounting	21
10. SPECIFICATIONS	22
11. MIDI IMPLEMENTATION	23
12. WARRANTY	24

1. INTRODUCTION

Thank you very much for the confidence you have placed in us by purchasing the EUROLIGHT LC2412. You now own an outstanding, ultra-compact light mixing console, that features the state-of-the-art digital DMX512 control. In addition, your LC2412 is equipped with an analog output which allows to use it virtually in every environment you can think of. The design of the LC2412 (how it operates and how it is programmed) was constructed with controlling dimmer packs and standard spotlights in mind. To optimally use multi-function spotlights such as scanners and moving heads, you should use control consoles specifically created for this purpose.

This user's manual is designed to give you an overview of all the controls, so that you get to know all possible applications the LC2412 offers. General safety instructions are followed by a structured overview of the control panel. Afterwards, all functions of your LC2412 are described in detail.

Future-minded BEHRINGER technology

To allow for the highest possible level of operational safety, we manufacture our equipment under the highest quality standards in the industry.

Your LC2412 has been manufactured under ISO9000 certified management system.

 **The following user's manual is intended to familiarize you with the unit's control elements, so that you can master all the functions. After having thoroughly read the user's manual, store it at a safe place for future reference.**

1.1 Before you get started

1.1.1 Shipment

The LC2412 was carefully packed at the assembly plant to assure secure transport. Should the condition of the cardboard box suggest that damage may have taken place, please inspect the unit immediately and look for physical indications of damage.

 **Damaged units should NEVER be sent directly to us. Please inform the dealer from whom you acquired the unit immediately as well as the transportation company from which you took delivery of the unit. Otherwise, all claims for replacement/repair may be rendered invalid.**

1.1.2 Initial operation

Please make sure the unit is provided with sufficient ventilation, and never place the EUROLIGHT on top of an amplifier or in the vicinity of a heater to avoid the risk of overheating.

 **Before plugging the unit into a power socket, please make sure you have selected the correct voltage:**

The fuse compartment near the power plug socket contains three triangular markings. Two of these triangles are opposite one another. The voltage indicated adjacent to these markings is the voltage to which your unit has been set up, and can be altered by rotating the fuse compartment by 180°. **ATTENTION: This does not apply to export models that were for example manufactured only for use with 120 V!**

 **If you alter the unit's voltage, you must change the fuses accordingly. The correct value of the fuses needed can be found in the chapter "TECHNICAL DATA".**

 **Faulty fuses must be replaced with fuses of appropriate rating without exception! The correct value of the fuses needed can be found in the chapter "TECHNICAL DATA".**

Power is delivered via the cable enclosed with the unit. All required safety precautions have been adhered to.

 **Please make sure that the unit is grounded at all times. For your own protection, you should never tamper with the grounding of the cable or the unit itself.**

1.1.3 Warranty

Please take a few minutes and send us the completely filled out warranty card within 14 days of the date of purchase. You may also register online at www.behringer.com. The serial number needed for the registration is located at the top of the unit. Failure to register your product may void future warranty claims.

1.2 The user's manual

The user's manual is designed to give you both an overview of the controls, as well as detailed information on how to use them. In order to help you understand the links between the controls, we have arranged them in groups according to their function. If you need to know more about specific issues, please visit our website at <http://www.behringer.com>.

1.3 General features and functions

"LC2412" means: 24 preset channels and 12 memory channels. But that's hardly all: You can simultaneously control 78 dimmer channels via the DMX512 digital interface (26 console channels x 3 DMX channels). And because several light units can be operated on a single dimmer channel, this console gives you a plethora of mixing possibilities.

EUROLIGHT LC2412

Comparable to a mixing console in a recording studio, a light mixing console is a switching central for stage lighting. Therefore, a light mixing console has to be absolutely reliable and under no circumstances leave you stranded. We created our LC2412 using the most modern components in order to guarantee you the maximum reliability possible.

But without functionality, no amount of reliability is of use to you. That's why we integrated a tremendous number of functions in an extremely compact unit. You have always full control of the light conditions, regardless whether you run the light show at a live concert, a club or on a stage. To enable you complete control over the current setup, the EUROLIGHT LC2412 has an intuitive design structure and features a large number of LEDs and a large LCD display.

A light mixing console is basically a controlling unit that comprises a full system once it is integrated with a power source and light elements.

Two different standards have established themselves in the field of light control (analog controlling with 0 to +10 V and digital controlling via the DMX512 control protocol). Your LC2412 is compatible with both. The extent of controlling your lighting situation can range from simply fading lights in and out, all the way to configuring and programming entire light shows. You can manually control the speed at which a program runs, enter the desired speed into a preset for each step, or let it be automatically determined by an internal beat generator. On the other hand, you can control this beat generator by using a fader, or let your musical program directly determine the beat for the lighting setup.

Presets

Complex lighting situations can be set up using single faders (each controlling up to 24 channels, whereby up to 72 single dimmers can be controlled). You can light up individual channels at full blast independently from their fader position using the *FLASH* keys.

Memories

Presets can be stored into ten separate preset banks (with twelve memory slots each), and can also be individually recalled. All memories can be archived by using separate PCMCIA memory cards.

Chases

The expression "Chases" refers to situations in which individually programmed light steps (up to 99 steps) are executed in succession (the lights "chase" each other). These steps can be both individual presets as well as memories.

You can create extremely complex chases. For example, parameters such as fade-in speed of a step, chase sequence speed and their control via the built-in beat generator or music can all be programmed.

Crossfade

There are several ways to alternate between various stored or newly developed lighting situations. Conversely, you can also alternate back and forth between individual steps of a single chase manually or automatically.

Preview

With this function, you can preview stored memories or chases without these being visible on the stage. This way, you can discretely control the next step before letting it be seen on the stage.

Sound to light

This function is more widely known as "party light". It basically means that your music drives the light show. An incoming music signal is broken down into three frequency ranges (bass, mids and highs), each of which is assigned to a (memory) channel. Depending on the volume of the respective signal segments, the lights assigned to them will shine accordingly. You can even program a setup for song pauses.

MIDI

The LC2412 can be controlled via MIDI. Two EUROLIGHT LC2412s can be operated as master and slave by using the MIDI interface. Entire shows can be stored and recalled by means of a MIDI sequencer.

DMX512

The DMX digital protocol lets you flexibly assign 78 of the 512 digital channels to individual light console channels (**softpatch**).

Memory card

The EUROLIGHT LC2412 offers you access to 120 storable lighting setups (memories) that can easily be altered. A virtually unlimited archive of lighting setups can be created by using the interchangeable memory cards on which these setups are stored. The sky is the limit when you put your creativity to the test with the 99 programmable chases, each consisting of 99 single steps.

2. CONTROL ELEMENTS

The control panel of your LC2412 is divided into various areas with different functions. The way the controls on the LC2412 were designed makes using the unit and capturing current settings a breeze. The control elements are described on the following pages according to the functions they play. If parts of the unit are shown in light grey in an illustration, that means that these controls belong to another section (described elsewhere in the manual).

All control elements and function keys are provided with control lights to enable you full oversight of the setup/functions currently selected.

The sections: **1** A *PRESET* section, **2** B *MEMORY*-section + bank display, **3** sound to light, **4** *FLASH* keys, **5** programming section, **6** *MAIN* section, **7** *CHASE* section.

The LC2412 also has additional functions that cannot be assigned to a particular section (special channels):

- 8** *SPECIAL 1* key. Used to activate a special channel, for example for turning a fog machine on/off.
- 9** *SPECIAL 2* key. The same function as *SPECIAL 1* key. Just like in the case of other channels, three DMX channels can be assigned to these two channels (i.e. to *SPECIAL 1/2*). Both special channels are then labeled as channels 25 and 26 on the console. *SPECIAL 1* and *SPECIAL 2* keys can be programmed as switches, keys or kill keys. Additional information on this subject can be found in chapter 7.3.
- 10** *POWER* switch. Used to power up the EUROLIGHT LC2412. The *POWER* switch should always be in the "Off" position when you connect the unit to the mains.
-  **Please take note: Merely switching the unit off does not mean that it is fully disconnected from the mains. When not using the unit for prolonged periods of time, please unplug the unit's power cord from the power outlet.**
- 11** The BNC connector is used for connecting a gooseneck lamp (optional).

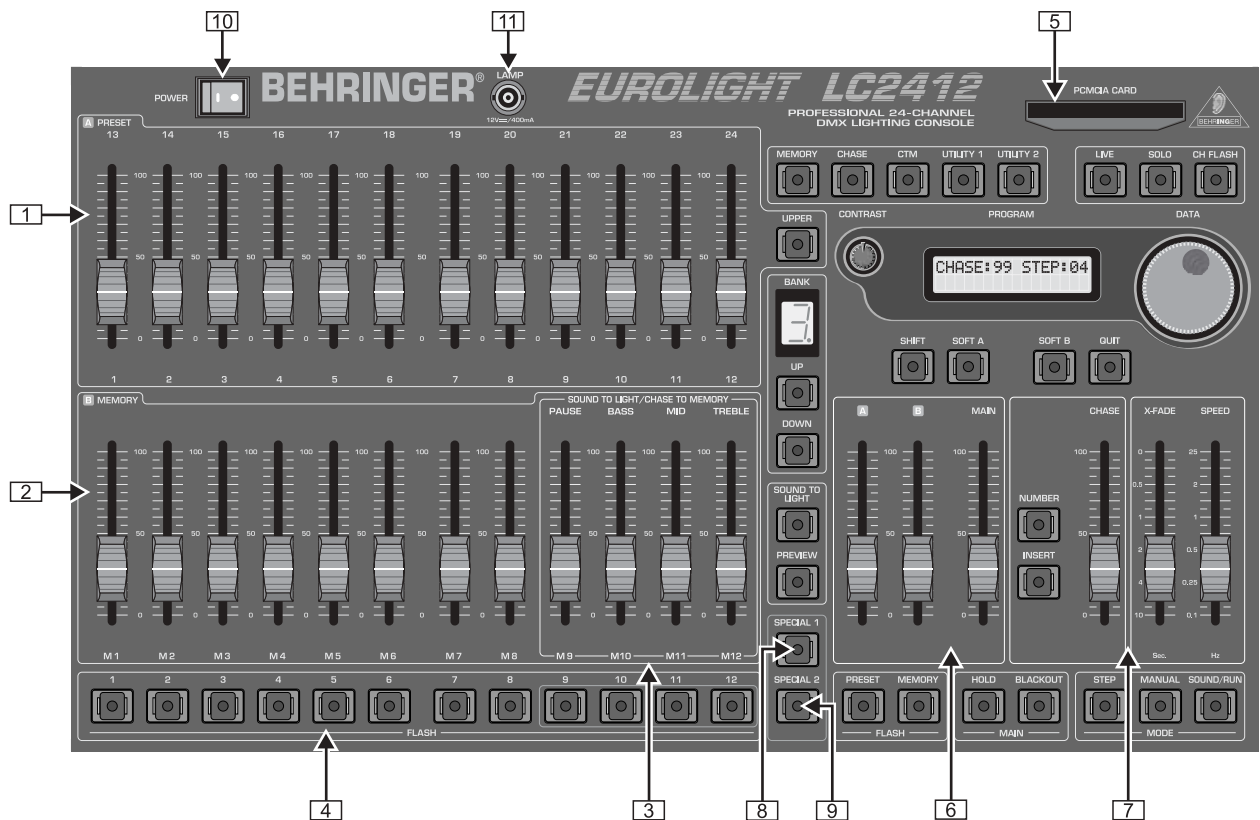

Fig. 2.1: Section overview

2.1 Control elements of the A PRESET section 1

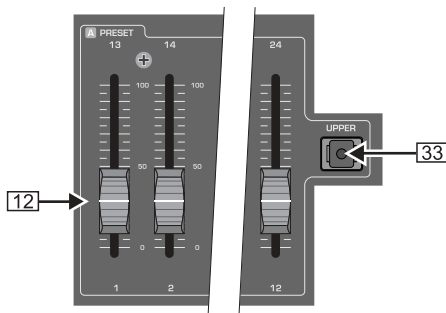

Fig. 2.2: A PRESET section (detail)

- 12 Faders 1-12. Used to set the intensity of light elements connected to the dimmer pack.
- 33 UPPER switch. When you press this switch, the A PRESET section is switched to the twelve additional channels. After that, you can set up the intensity of channels 13 - 24. See also chapter 3.2.

Setting up presets

Channel faders are used for setting up a preset that can be directly recalled by moving fader A 41. As in all other setups, the MAIN fader 43 (see chapter 2.6) determines the maximum illumination level of selected light sources.

2.2 Control elements of the B MEMORY section 2

The faders of the B MEMORY section are located in the block underneath the A PRESET section.

- 13 These faders control the illumination level of an entire group of channels in a ratio to one another that you previously determined by setting up the A PRESET faders and saving this setting as a memory.

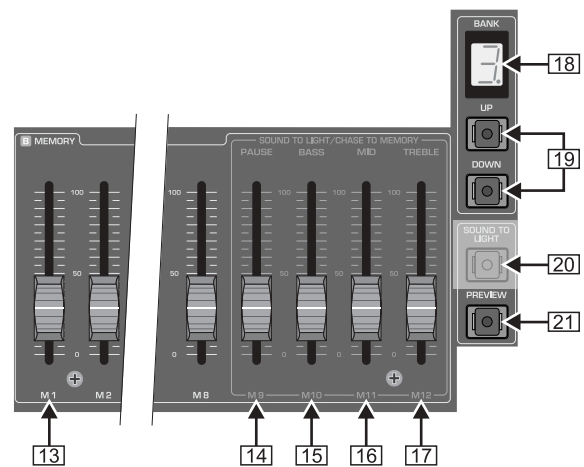

Fig. 2.3: B MEMORY section

Exception: When the LC2412 is in preset mode ("P" shown in the bank display), the faders control the same channels as the faders of the A PRESET section. This way, you can simultaneously create a second preset.

- 14-17 These faders are also a part of this section, but they have a double function. When the LC2412 is in sound to light mode (party light function), they control the illumination level of individual memories assigned to particular frequency ranges.
- 18 The BANK display shows the storage bank to which the memories you recall belong. It also shows if the LC2412 is currently in preset mode ("P" displayed). The display starts flashing when you switch into preset mode, and lights up constantly after three seconds. The preset mode is active only after the flashing has stopped. This prevents accidental activation of the preset mode as well as rough fades.

EUROLIGHT LC2412

[19] *UP/DOWN* keys. Use them to select a preset bank (0 - 9) or switch into preset mode (P). The control lights flash when you select a new bank while memories from the previous bank are still active (the fader(s) is(are) pulled up). Pull the fader(s) ([13], [14]-[17]) down to fade the memory out. When you pull the fader(s) up again, the memory of the new preset bank is visible on the stage (also see chapter 4.1.2).

[20] *SOUND TO LIGHT* key. See chapter 2.3.

[21] *PREVIEW* key. It gives you the option to preview (or modify) stored memories one more time before implementing them on the stage. This is particularly useful when you saved chases as memories and wish to double-check and/or modify their speed before integrating them into a running show. When "preview" is activated, the chases are shown on control LEDs exclusively.

Each fader is assigned to a FLASH key (section [4]). This key is used to assign a specific bank position to individual presets while programming a memory.

2.3 Control elements of the SOUND-TO-LIGHT section [3]

The *SOUND-TO-LIGHT* controls are located in the right-hand section of the B MEMORY section.

If the sound-to-light function is active, memories 9 - 12 are controlled by a music signal, whereby the volume of the signal dictates the illumination level of the memories. The music signal is divided into three frequency ranges (bass, mids, highs). One memory slot is assigned to each of the three frequency ranges. For optimal results, please put the faders to the middle position. This will let you bring individual settings of memories into sync with one another, should the levels vary from memory to memory.

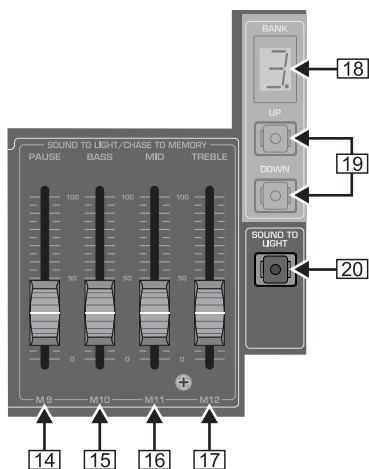

Fig. 2.4: The *SOUND-TO-LIGHT* section

[14] The *PAUSE* fader is, just like the fader [13], used primarily to control the illumination level of memories. If the sound-to-light function is active, it controls a memory slot assigned to run during program breaks between two musical pieces.

[15] The *BASS* fader takes over the basic configuration of the illumination levels for the memory slot assigned to the bass portion of the frequency range.

[16] The *MID* fader is conversely assigned to the mids.

[17] The *TREBLE* fader is conversely assigned to the highs.

[18] and [19]: Bank display and *UP/DOWN* keys, see chapter 2.2.

[20] The *SOUND-TO-LIGHT* key activates the sound-to-light function.

The music signal necessary for controlling the show can be fed into the *ANALOG INPUT* connector located at the rear of the LC2412.

2.4 Section [4]: FLASH keys and SOLO

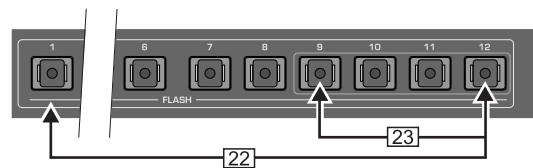

Fig. 2.5: The *FLASH* keys

[22] *FLASH* keys. Pressing one of the *FLASH* keys sets the respective channel to the maximum illumination level set on the *MAIN* fader, independent from its own fader position. For this purpose, the *CH FLASH* key [32] has to be pressed. The channel flash function is automatically activated in preset mode.

[23] Dual-function *FLASH* keys. Memories or chases can be stored to memory positions 9 - 12 (chase to memory). When a respective storage bank is selected, chases are indicated with yellow LEDs. Chases can also be recalled by using the *FLASH* keys.

Solo

When the solo function is simultaneously active (*SOLO* key [31], LED lit), all other emitters or light elements are deactivated. Only the channel selected via the *FLASH* key is still active.

2.4.1 Disabling the solo function

You have the option to exclude specific channels from the solo function, so that these channels remain active even when "Solo" is activated.

Disabling solo is achieved by performing the following programming sequence:

1. Press *UTILITY 1* [28].
2. Select the option *DISABLE SOLO* by using the *SOFT A* key [38] located below the display. The channel for which the solo function should be disabled or enabled is shown in the top left section of the display. The respective disabled/enabled status of the said channel is indicated to the right of the channel number itself.
3. To select the channel you wish to adjust, turn the *DATA* wheel [36]. The desired channel can also be selected by using the *FLASH* key (for channels 13 - 24: first press the *UPPER* key).
4. *SOFT B* [39] selects "DISABLE" and thus disables the solo function for this channel; *SOFT A* selects "ENABLE".
5. To exit this procedure, press the *QUIT* key [40], thus confirming the procedure.

When you disable the solo function for a particular channel, the channel remains active in case when it is part of an activated memory that fades after pressing one of the *FLASH* keys.

Example:

You have disabled the solo function for channel 8. The light on channel 8 remains lit if you press one of the *FLASH* keys, as long as the solo function is active.

Previously, you have programmed a memory that uses channel 8. The memory has just been activated on the stage. Now, press one of the *FLASH* keys (*CH FLASH* [32] is also activated). There are **two** lights on the stage, i.e. channel 8 **and** the channel activated with the key!

2.5 Control elements of the programming section 5

Despite its compact size, the EUROLIGHT LC2412 is a versatile light mixing console. In it, we have integrated a plethora of functions, among others, various functions for memories, chases and digital control. The basic elements of the programming section are located at the top right section of the unit. To let you quickly orient yourself in difficult situations, the LC2412 also features a display.

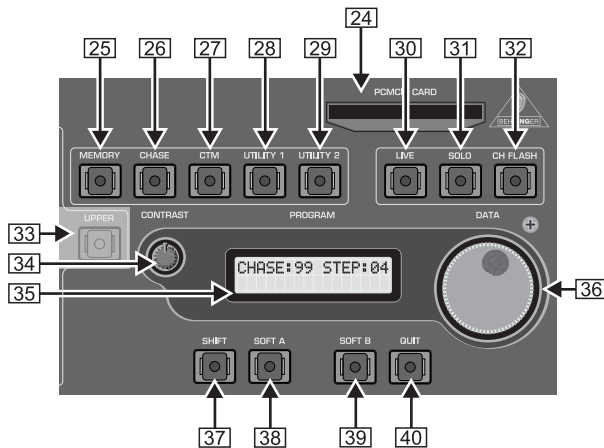

Fig. 2.6: The programming section

- 24 **PCMCIA CARD** slot. This interface accepts the memory card on which you can store your console setups.
- 25 **MEMORY** key. By pressing the MEMORY key once, you initiate the procedure that saves a stage scene. How this procedure functions in particular is explained in greater detail in chapter 4.1.
- 26 **CHASE** key. Used to initiate the programming procedure (intended for creating a chase). How this is done is explained in chapter 6.1.
- 27 The **CTM** key (stands for chase to memory) brings up the menu for storing chases. Basically, you can store completely programmed chases into memory. Each of the ten memory banks has four memory slots (9 - 12) available for this purpose.
- 28 **UTILITY 1**. This key takes you to the following programming menus: DISABLE SOLO, SELECT CURVE and THEATRE MODE.
- 29 **UTILITY 2**. This key takes you to the following programming menus: DMX PATCH, SELECT MIDI and SELECT SPECIAL. Further information about these functions is to be found in chapters 7 and 8, "ADDITIONAL FUNCTIONS OF THE LC2412" and "DIMMER CONTROL".
- 30 **LIVE** key. By pressing this key, you can route chase or memory steps to the console's output in order to see what it would all really look like on the stage. This also makes sense for the programming procedure itself, because chases are for example only shown on the LEDs during their selection (normal setting, blind mode). This way, selecting chases is even possible while a program is running on the stage, without disrupting the program itself (automatic preview). The live mode changes everything the other way around: only the settings observed in the preview function are visible on the stage.
- 31 **SOLO**. The solo function utilizes the FLASH keys. When the solo function is active, pressing the FLASH key for a single channel/memory completely dims all other lights. If so desired, individual channels can be taken out of the solo function's reach (see chapters 4.3.1 and 2.4.1).
- 32 **CH FLASH** key. Switches the channel flash function on and off. When the channel flash function is on, you can

use the FLASH keys (22+23) to enable the highest illumination level on individual channels. This function is automatically activated in preset mode (see chapter 3.1.1). However, it has to be manually activated in memory mode.

- 33 **UPPER** switch. Used to switch over to channels 13 - 24. See also chapters 2.1 and 3.2.
- 34 **CONTRAST** control. Turning this pot lets you adjust the display contrast.
- 35 **PROGRAM** display. Depending on the programming procedure, different menus are shown here. If you haven't programmed anything yet, or if you have quit a programming procedure by means of pressing the QUIT key 40, the display shows the current chase and the respective step (basic setup).
- 36 **DATA** wheel. Used to change/select programming parameters. For example, it can be used for programming chases, during which you dial in steps and determine their execution speed. Besides, it is also used for directly calling up chases (see also chapter 6.2).
- 37 **SHIFT** key. Opens additional programming menus. A more detailed explanation can be found in the description of the respective programming procedures.
- 38 **SOFT A** key. Needed for selecting items while in a programming menu. The menu texts and the SOFT A key are ordered in such a way that this key lets you select the options above (appearing in the menu).
- 39 **SOFT B** key. Has the same function as the SOFT A key.
- 40 **QUIT** key. Used for closing a programming procedure and going back to the main menu.

2.6 Control elements of the main section 6

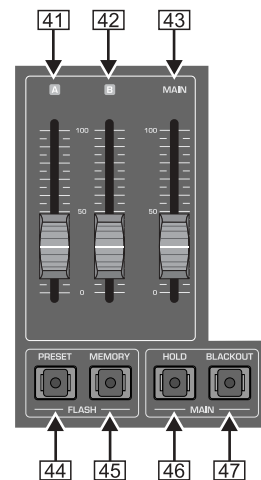

Fig. 2.7: The main section

Control elements that apply to function groups or the entire console are grouped in the main section.

- 41 **A fader**. This fader is the master fader for the A PRESET section; it determines the maximum illumination level of the entire section. The FLASH keys (22/23) as well as 44/45) can still be utilized, even when the fader is at its zero position.
- 42 **B fader**. This fader is the master control for the B MEMORY section; it determines the maximum illumination level of all memories. Just like in the case of the A fader, the FLASH keys can be utilized even when the fader is at its zero position.

When the MAIN fader is raised up, both of these faders (A and B) can be used to fade in and out between the settings of both of these sections.

EUROLIGHT LC2412

- [43] **MAIN** fader. It determines the maximum illumination level of all commands at the console's output.
- [44] **PRESET FLASH** key. You can execute the entire A PRESET section with this flash key, that is, activate the A PRESET section on the stage, even if the the A fader [41] is fully down. As soon as you let go of the key, the lights fade again. More information about this subject is found in chapter 4.3.
- [45] **MEMORY FLASH** key. Has the same function for the B memory section.

Also, two additional keys in this section affect the entire console output:

- [46] **HOLD** key. Freezes the current settings, while you select a new preset, recall a different memory or implement an entirely different configuration. This procedure is described in chapter 7.2.
- [47] **BLACKOUT** switch. Completely dims all lighting elements. This function affects the entire console output, that is, it also affects the chases. The dimming is done abruptly. If you want the dimming to take place softly, use the **MAIN** fader. Console settings can be altered while the console output is deactivated. To illuminate the stage again, hit the **BLACKOUT** key again. The control LED dies out.

2.7 Control elements of the chase section [7]

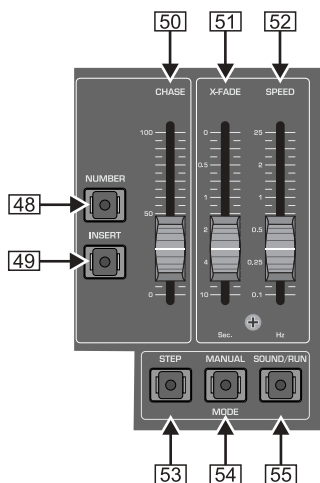

Fig. 2.8: The chase section

- [48] **NUMBER** key. Selects a chase, enabling you to show individual chases on the control LEDs (automatic preview). The control LED of the **NUMBER** key lights up, as long as chases are active in any form. This means, the LED lights up even when the chase is not active, but just "dialed in", ready for action. When you select a chase whose steps have still not been programmed, the LED dies out after letting go of the key. The LED also dies out when the **CHASE** fader [50] is pulled down.
- [49] **INSERT** key. Activating this key while a chase is running lets you alternate between the current step and the one preceding it by pressing the **STEP** key [53]. This function can also be executed utilizing the **X-FADE** control (**MANUAL MODE** key [54] activated). Additional information on this subject can be found in chapter 6.2.6.
- [50] **CHASE** fader. Controls the illumination level of a complete chase setup. Separate ratios of a memory incorporating this chase remain intact.
- [51] **X-FADE** control. Used to manually dissolve between individual chase steps. Can also be used to dissolve between memories. Additionally, fade-in speed of chase steps can be configured, provided this speed was not already determined in theatre mode (only when theatre

mode is active). More detailed information on this subject can be found in chapters 6.2.3 and 7.4.

- [52] **SPEED** fader. Controls chase speed.
- [53] **STEP** key. Manually triggers chase steps. This can also be done while chases are already active. This function can also be remotely controlled by using a footswitch.
- [54] **MANUAL MODE** key. Assigned to the **X-FADE** control. When the **MANUAL MODE** key is activated, turning the **X-FADE** control back and forth either fades back and forth between two chase steps (**INSERT** key activated) or fade chase steps in after one another (**INSERT** key deactivated). A more detailed overview of the various possibilities of fading in/out can be found in chapter 6.2.4.
- [55] **SOUND/RUN MODE** key. Selectively activates chase control by means of bass rhythm (**SOUND**) or by means of the internal speed control (**RUN**).

2.8 Rear panel connectors of the LC2412

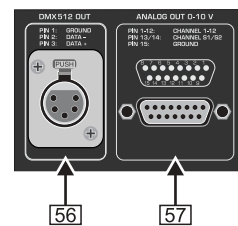

Fig. 2.9: Digital and analog outputs

- [56] **DMX512 OUT** connector. The digital output of the LC2412 is provided by means of a 5-pole XLR connector. You can connect a dimmer pack. It can be used to process digital control commands according to the DMX512 control protocol.
- [57] **ANALOG OUT** connector. The analog output is meant for controlling via the analog standard (0 to +10 V DC) and is implemented as a Sub D connector. Used to connect dimmer pack that don't use the modern DMX512 control protocol.

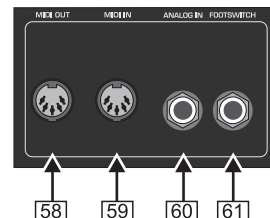

Fig. 2.10: Additional back-panel connectors

- [58] **MIDI OUT** connector. MIDI data can be forwarded from the MIDI OUT connector to a second LC2412 or another MIDI sequencer/PC by using a corresponding cable (connect it to the MIDI IN connector on the receiving unit). This lets you control two consoles in parallel, that is, a total of 156 DMX channels are at your disposal.
- [59] **MIDI IN** connector. Used to feed in MIDI data (e.g. from a MIDI sequencer or another LC2412) to control the LC2412.
- [60] **ANALOG IN** connector. Connect an output of your mixing console, your CD player or another analog signal source to this 1/4" TS mono jack connector. This lets you use the sound-to-light function and musical control of chases.
- [61] **FOOTSWITCH** connector. Connect a footswitch here to remotely control the **STEP** key. Additional information about this subject can be found in chapter 6.2.4.

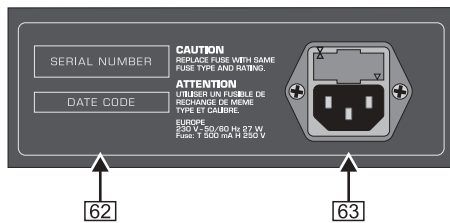

Fig. 2.11: Serial number and mains connector

62 SERIAL NUMBER. Please take a few minutes and send to us a completely filled out warranty card within 14 days of the original date of purchase. Otherwise, warranty claims may be rendered invalid. Or visit the warranty information online at www.behringer.com.

63 FUSE COMPARTMENT / VOLTAGE SELECTION. Before connecting the unit to a power outlet, please make sure that the selected voltage matches your local voltage. When replacing fuses, please make sure that you always use fuses of the same type. Some units allow for switching between 230 V and 120 V. Please note: when connecting a unit intended for the European market to a 120 V power outlet, you must also replace the factory fuse with a higher-value fuse.

Power is supplied via an IEC connector. The matching cable is provided with the unit.

3. PRESETS

This chapter describes individual steps used to set up, recall and fade in/out presets (pre-determined lighting situations). Even though your LC2412 can execute complex functions, its controls are easy to master, provided you invest some time to familiarize yourself with the way they work. To familiarize you with the control elements and their functions step by step, let us begin with setting up presets (preset = the total collection of all fader positions of the A PRESET section at one particular time). Let's start with 12 channels first.

All statements referring to channels 1 - 12 apply also to channels 13 - 24 (upper mode).

Think of presets as building blocks used to create more complex lighting situations: memories capture the setup of a preset (up to 24 channels) on one fader; chases use presets (level step) as well as memories (memory step) as single steps.

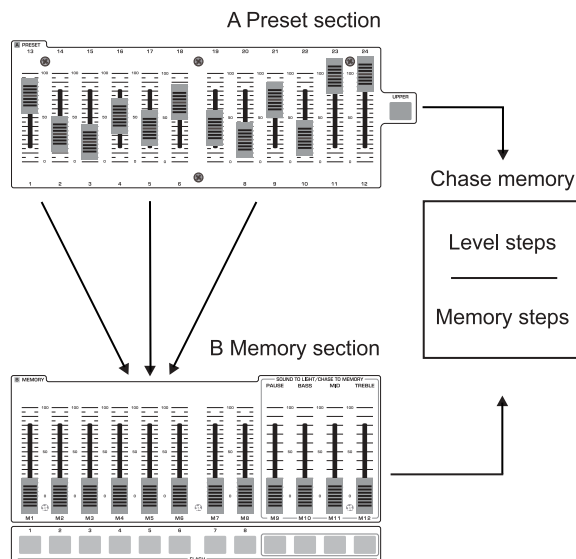

Fig. 3.1: Using presets and memories

3.1 Basic configuration

Pull all the faders all the way down to the zero mark. This way, you assure that you start your exploration of the possibilities of the LC2412 from a neutral setting, and can observe the results of the changes you implement directly. Use the POWER switch to power up your BEHRINGER EUROLIGHT LC2412. The LC2412 displays now the setup that was most recently used, just prior to being powered down last time.

If you want to start completely from the beginning, you can use a key combination to **erase all programmed configurations**. More on this subject in chapter 7.8.

3.1.1 Preset mode

To work exclusively with presets, you have to first switch into preset mode. Select "P" in the bank display accordingly.

1. Press the UP or DOWN keys repeatedly until "P" is shown in the display. The display flashes for roughly 3 seconds.
2. Once the flashing stops, your LC2412 is in preset mode. The CHANNEL FLASH function is now automatically activated, which is also shown by the lit control LED (CH FLASH **32**).
3. Raise the MAIN fader **43** as well as Fader A **41**.
4. You can now use faders 1 - 12 of the A PRESET section to create a stage design. The illumination level of individual lighting elements can be read out on the control LEDs, aligned next to the FLASH keys.

You can not program or recal memories while in preset mode. On the other hand, stored chases can be recalled while in preset mode.

3.2 Expanding to 24 preset channels (upper mode)

All operations applicable to channels 1-12 can be executed on channels 13 - 24, once you switch into upper mode.

1. Press the UPPER switch **33**.

The control LED indicates that the LC2412 is now in upper mode, that is, that the faders of the A PRESET section now control channels 13 - 24. The faders from the B MEMORY section affect channels 13 - 24 while in preset mode.

2. Set up your preset by moving the faders of the A PRESET section into the desired position.

In case you had already executed setups to channels 13 - 24, you have to first put the faders into the previously selected position before being able to again align these channels.

3. To quit upper mode, simply press the **33** switch.

After switching over, the control LEDs indicate the illumination condition of the respective active channels independent of the position of the faders. To alter the setting of a channel, you have to first bring the respective fader into the previous position.

Additional features:

While in upper mode, the FLASH keys fade in the channels 13 - 24.

3.3 Crossfading between presets

To crossfade between two presets, you need an additional preset. This additional preset is created by utilizing the faders in the B MEMORY section.

1. Pull the fader B **42** upward, the fader A **41** downward. The MAIN fader remains open.

EUROLIGHT LC2412

- Now, set up the lighting situation by using the faders of the B MEMORY section. As always, you can observe these changes on the control LEDs.
- Move the master B fader downward, then move the master A fader upward. Preset B is faded out, while preset A is faded in (manual fade).

4. THE B MEMORY SECTION

In this context, "memory" means a lighting situation (preset) stored as a unit.

The memory function is organized as follows:

There are ten storage banks, each with twelve storage slots (FLASH keys 1 - 12), used to store complete lighting situations (24 channels). The illumination level of the individual lighting situations (stage designs) can be determined by using the faders assigned to them during the programming procedure.

You can use memories in several ways:

- Fade them in manually or suddenly;
- Crossfade between presets and memories;
- Crossfade between different memories;
- Crossfade between memories from different memory banks. Memories originating in different banks can simultaneously be active.

4.1 Programming, recalling and altering memories (scenes)

4.1.1 Programming

- Set up a stage design (scene) while in preset mode (Fader A PRESET section).
- To store a scene, you must first quit the preset mode. By using the UP/DOWN keys [19], you switch into the memory mode. The bank display [18] indicates which storage bank is selected.

Press the MEMORY [25] key in the programming section. The display [35] shows the following text (an example):



Fig. 4.1: Display "Program memory"

The meaning behind the above line: the next step (select memory), location (memory slot number/storage bank).

You have already selected a storage bank using the UP/DOWN keys (7), and now use the FLASH keys to select a location.

Lower line: Make a selection by pressing SOFT A (preset) or SOFT B (all).

If you only want to store the adjusted preset, please press SOFT A [38]. If you also want to store an active memory along with the adjusted preset, then press SOFT B [39].

This way, you have the option to generate several variations out of a single memory. How memories are modified is explained in chapter 4.1.3.

Should you wish to store additional presets, simply repeat the steps:

- Adjust the preset (stage design);
- Select a storage bank using the UP/DOWN keys;

- Specify the storage location by pressing one of the FLASH keys [22]/[23];
- Store the preset or the console output (SOFT A or B);
- If you do not wish to create any more memories, press the QUIT key [40] to exit.

4.1.2 Fading in scenes

To fade in a programmed scene, simply select a storage bank by using the UP/DOWN keys and pull up a fader from the B MEMORY section. The fader whose assigned FLASH key you last pressed while programming is the fader that will control this memory.

To view a memory setup on the stage and on the LEDs, both fader B [42] and MAIN fader [43] have to be pulled up.

Recalling memories instantly

By using the FLASH keys (section [4]), you can recall the memories from the bank you just adjusted, just like retrieving individual channels in preset mode ("P" shown in the display).

The channel flash function must not be active at this time (CH FLASH key [32]).

4.1.3 Previewing and modifying memories

To preview memories before fading them in, use the PREVIEW key [21] to deactivate the console output for this procedure. The setup can only be observed on the control LEDs. The remaining functions of the EUROLIGHT LC2412 remain active.

After you press the preview key, the display shows the selected memory bank at the top right side. Select the memory that you wish to control by using one of the FLASH keys. The memory is then displayed by means of control lights only.

If you wish to modify the memory shown in preview mode, select the MODIFY function shown in the display by using the SOFT B [39] key (see fig. 4.2).



Fig. 4.2: Display "Editing memory in preview mode"

You can implement the desired changes now by using the faders of the A PRESET section. To change the programmed settings of preset faders, you must first draw the fader to its original position. The channels not activated during the previous programming can be raised as usual.

To save your settings, please select ENTER by using SOFT B. Either confirm the next memory or quit the preview mode by hitting the QUIT key [40].

Otherwise, you can also program the memory anew, as described at the beginning of this chapter.

4.2 Crossfading between different setups

4.2.1 Crossfading between presets and memories

Crossfading between memories and presets works exactly the same way as crossfading between two presets. The only difference is that the EUROLIGHT LC2412 has to be in memory mode.

- Activate a stored scene (see chapter 4.1.2).
- Activate a preset by using a fader from the A PRESET section; fader A remains locked.

- Now pull fader B down and fader A up. The preset appears at the console output, while the memories disappear.

4.2.2 Crossfading between memories

There are several ways to crossfade between memories:

Crossfading steplessly using the FLASH keys

Please take the following required steps, as follows:

- Disengage the CHANNEL FLASH key [32];
- Pull up the CHASE fader [50];
- Press the INSERT key [49];
- Adjust the X-FADE control [51] to the desired fade in/out speed;
- Press the FLASH key (one of the [22]/[23] keys).

The memory is faded in. You determine the illumination level by using the CHASE and the MAIN fader. To switch to another memory, simply press another FLASH key. You can alternate between two memories (the current one and the one selected before it) by using the STEP key [53]. You can fade in the current preset setting instead of the memory by using the PRESET FLASH key [44].

 **Faders A and B ([41] and [42]) as well as the faders of the B MEMORY section and the A PRESET section can be pulled down; in that case, only the memories/presets activated by means of the FLASH keys are visible.**

 **If you are currently replaying a chase, it will be interrupted as soon as you hit the INSERT key. When you hit the INSERT key for the second time, the chase resumes.**

Manually crossfading between memories using the X-FADER

If you activate the MANUAL key [54] in addition to the setup described in chapter 4.2.2, you can then determine the crossfade times by switching from memory to memory using the X-FADE fader.

- Select a memory using a FLASH key.
- Now, move the X-FADE fader to an end position, and the memory will be faded in.

 **If you select no new memory, you can alternate between the two most recently used memories back and forth.**

Fading memories out

To fade memories out, release the INSERT key [49]. If you pull the X-FADE fader in the same direction while having faded in a memory right before that, the memory is faded out only when you pull the control down again. Renewed pulling the control upwards, no memory is displayed.

 **Activating a chase and interrupting it by pressing the INSERT key fades in the next CHASE step when you pull the X-FADE fader upward. To fade out, you have to first select a chase that contains no steps (see chapter 6.2).**

When you let go of the MANUAL key, using the STEP key [53] lets you fade out withing the time set up using the X-FADE fader.

 **When a chase is active, and you interrupt it by pressing the INSERT key, pressing the STEP key fades the next chase step in.**

4.2.3 Crossfading between memories of different banks

You can change your current storage bank by selecting a new bank using the UP/DOWN keys. The memory activated

previously remains on the stage until you pull the fader to zero. The LEDs of the UP/DOWN keys flash in case there are active memories belonging to the “abandoned” bank. Pull up a memory fader, and the memory stored at this location in the new storage bank is activated.

 **The memories that were activated before you changed the bank remain visible on the stage until you pull the fader down into its zero position. This way, you can see multiple memories on the stage (and the respective control lights).**

4.3 Preset flash and memory flash

4.3.1 Preset flash

This key activates the flash function for the A PRESET section. If the solo function is not active, PRESET FLASH adds a lighting configuration (set up in the A PRESET section) to an active memory (fader A [41] at zero). When the solo function is active, “pulled up” memories are switched off.

Configuration:

Memory mode, memory fader [13] raised

Fader A [41] closed, MAIN fader [43] raised

Fade in the preset configuration using PRESET FLASH. The A PRESET fader and the MAIN fader determine the illumination level.

With solo function: memories are deactivated.

4.3.2 Memory flash

The “memory flash” function can be activated to abruptly implement stored presets (memories) into an active preset, instead of smoothly fading it in using a fader.

 **No memory can be recalled in preset mode. Additionally, the “memory flash” function can not be executed.**

Configuration:

Memory mode, memory fader [13] raised,

Fader A raised, fader B closed or partially raised, MAIN fader raised.

Fade in the “pulled up” memories using the MEMORY FLASH. The B MEMORY fader and the MAIN fader determine the illumination level.

With solo function: The preset is deactivated.

4.4 Programming memories without direct control (blind)

In addition to programming memories by using the preview function (see chapter 4.1.3), you can also program memories using yet another method, without being visible on the stage. Make sure that the LIVE key [30] is not active. The fader A also has to be in its zero position.

After having pressed the MEMORY key [25] in the programming section, select a storage bank by using the UP/DOWN keys and a memory by using the FLASH key, and edit it by using the faders from the A PRESET section. The fader configurations are only indicated by means of control lights on the FLASH keys.

Please confirm your changes by hitting the SOFT A (preset) or SOFT B (all) keys and then edit another memory, or quit by hitting QUIT.

4.5 Previewing memories individually on the stage (live mode)

Live mode gives you the option to preview individual memories and chases *on the stage*, without having to interrupt the program currently running. Therefore, live mode changes the usual sequence of events that allows you to run a show on the stage while previewing and editing chases and memories in the background by using *the control LEDs*.

In live mode, when preview function is active, you can activate and edit memories on the stage, without interrupting the current program. It is not visible for the entire duration of the procedure. The same goes when selecting a chase: The chase is shown on the stage when the NUMBER key [48] is pressed.

1. First activate PREVIEW.
2. Press the LIVE key [30] to activate live mode.
3. Use the FLASH key to select a memory. The selected memory will be displayed. By using the "MODIFY" function, you have the option to modify the memory.
4. Select "MODIFY" with the SOFT B key, edit the memory by using the faders of the A PRESET section, and confirm your changes with SOFT B ("ENTER").
5. To quit live mode, disable it by pressing the LIVE key again.

4.6 Additional application of memories

Additional options for using memories stand at your disposal:

1. Implementing memories as "building blocks" for chases (memory chase, chapter 6.1.2);
2. Implementing memories 9 - 12 via the sound-to-light function, that is, automatically controlled by music.

5. SOUND-TO-LIGHT

To use the sound-to-light function, you have to connect a line-level signal source (CD player, tape deck, mixing console output or similar) to your EUROLIGHT LC2412. To this end, there is a 1/4" TS mono jack connector (ANALOG IN [60]) at the back of the LC2412. Signal level adjustment is automatic. As described in chapter 2.3, the sound-to-light function affects the memories stored in slots 9 - 12.

Press the SOUND-TO-LIGHT key [20] and pull the faders [14] - [17] in the middle position. Overall illumination level can be corrected by using the MAIN fader.

You can vary the sound-to-light function by selecting a different bank. Right after switching to another bank, new memories are processed by the sound-to-light function. This is how the sound-to-light function is different from the usual bank change in memory mode.

The sound-to-light function can be freely combined with other console functions.

6. CHASE CONTROL

Chases are sequences of stage designs (presets or memories) that can be stored and can be run in a sequence. The LC2412 can store a total of 650 chase steps, and can store 99 chases in its memory, each of which can be comprised of up to 99 steps.

There are several options when running chases:

- ▲ control via the bass rhythm of a connected audio signal (e. g. CD player);
- ▲ control via the internal beat generator (speed set up using the SPEED fader [52]);

▲ Manually set up steps;

▲ Crossfading between steps from one to another by means of the X-FADE fader.

Before that, individual chase steps have to be programmed.

6.1 Programming or erasing chases

Chases can be combined out of presets (level chase) or out of memories (memory chase).

6.1.1 Programming level chase

1. Please press the CHASE key [26]. The program display [35] shows the following text (example):

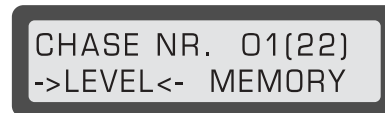

Fig. 6.1: Display "programming chases"

"LEVEL" is highlighted after presets have been stored; "MEMORY" is highlighted when memories have been stored as chase steps.

If "MEMORY" is marked, select a different chase (by using the DATA wheel [36]), in case you do not wish to overwrite the current one.

2. Select "LEVEL" by pressing the SOFT A key [38].



Fig. 6.2: Display "Programming level chase"

If the display shows a different text, please press the SHIFT key [37].

By turning the DATA wheel, you can view steps in succession.

3. You can edit a step you selected by means of channel faders of the A PRESET section. To change one or more already active channels, you first have to draw the respective fader(s) into the previously stored position (snap in).
4. Select "ENTER" with the SOFT A key and store this step. To delete a step, select "DELETE". The display automatically shows the next highest step.

Edit as just described or select another step by using the DATA wheel.

End the programming with the QUIT key.

6.1.2 Programming memory chase

1. Press the CHASE key [26] to begin programming, as described above.
2. Select a chase using the DATA wheel. The displays shows whether you are dealing with a level chase or a memory chase.
3. Select "MEMORY" with the SOFT B key.

👉 If you selected a level chase and then select "MEMORY" (or vice versa), you are asked (in the display) whether you wish to program a new chase. Select "YES" to overwrite the previous chase.

4. Select a storage bank using the UP/DOWN keys [19] and select a memory by pressing a FLASH key. This is indicated on the control lights.



Fig. 6.3: Display “programming memory chase”

The displays indicates the memory and the storage bank in which the selected memory is located. Example:

STEP: 01 09 (memory) 04 (bank).

5. Confirm your choice with SOFT A (“ENTER”).
6. Enter as many memories as you wish following the same procedure (max. 99 steps).
7. Exit the programming procedure by pressing QUIT.

6.1.3 Erasing chases

If you wish to completely erase a chase, do the following:

1. Press the CHASE key [26] to get to the CHASE menu. Use the DATA wheel to select a chase you wish to erase.
2. Use SOFT A or B (“LEVEL” or “MEMORY” in the display) to determine which chase type you wish to program after erasing chase steps. If you simply wish to erase, please select one option in order to get to the next window.
3. Activate the shift function by pressing the SHIFT key [37].

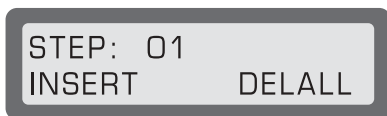

Fig. 6.4: Display “Erasing chases”

4. Use SOFT B to select “DELALL”. This way, all chase steps of the corresponding chase are erased. Now you can directly start programming a new chase. If you selected “MEMORY” under 2., you also have to press SHIFT.

6.2 Running and pausing chases

To select a chase: Keep the NUMBER key [48] depressed.

In the PROGRAMM display [35] you now have a readout of the number of active chases, the number of already programmed steps as well as the chase type (level or memory). At the same time, the chase is also shown in the control LEDs, but without being visible on the stage (automatic preview).

If you keep the NUMBER key pressed, you can use the DATA wheel [36] to view all programmed chases.

Use the SPEED control [52] to set the desired speed.

Letting go of the NUMBER key activates the chase.

To view the chase on the stage, pull up the CHASE fader [50] and the MAIN fader [43].

Pausing a chase

There are several ways to do this:

1. Pull the CHASE fader [50] down to “0” (faded out).
2. Press INSERT or MANUAL.
3. Disable SOUND or RUN mode.
4. Select a chase containing no programmed steps.

6.2.1 Chase control through music

When an audio signal source is connected at the ANALOG IN connector [60] at the rear of your EUROLIGHT LC2412, the speed of chases can be determined by the bass rhythm of the music. Of course, a chase must be selected.

Table 6.1 shows the necessary setup:

Key	On	Off
INSERT		•
MANUAL		•
SOUND	•	
RUN		•

Table. 6.1: Chase control through sound

You can also trigger chase steps by using the STEP key [53]. Use the X-Fade fader to regulate the fade-in speed.

6.2.2 Chase control by means of SPEED fader (RUN)

To control the beat time of a chase with the internal beat generator, you need to activate “Run” by repeatedly pressing the SOUND/RUN key [55] (yellow LED lights up).

Use the SPEED control [52] to control the speed.

Just like with chase control through music, you can also trigger chases at the same time with the STEP key (if applicable, you may use a footswitch connected to the FOOTSWITCH connector). Use the X-FADE fader to regulate the fade-in speed.

Key	On	Off
INSERT		•
MANUAL		•
SOUND		•
RUN	•	

Table. 6.2: Chase control via internal beat generator

6.2.3 Crossfading manually using the X-FADE fader (manual mode)

Press the MANUAL key [54]. Using the X-FADE fader, you can fade in an out between two adjacent chases.

Key	On	Off
INSERT		•
MANUAL	•	

Table. 6.3: Chase control via X-FADE fader

Each step is shown in the display; the STEP key is disabled. If you additionally enable the INSERT key, you can fade in and out between the two steps selected last.

Key	On	Off
INSERT	•	
MANUAL	•	

Table. 6.4: Fading in and out via X-FADE fader

6.2.4 Manual fades using the STEP key [53]

When the MANUAL, SOUND and RUN keys are disabled, you can trigger chases only by using the STEP key (or a footswitch).

Key	On	Off
INSERT		•
MANUAL		•
SOUND		•
RUN		•

Table. 6.5: Chase control via the STEP key

EUROLIGHT LC2412

Insert

If you additionally activate the INSERT key, you can crossfade between the two most recently selected steps.

 If you are currently playing a chase, you can pause it by pressing the INSERT key. Pressing the INSERT key for the second time restarts the chase again. INSERT and MANUAL can also be used in SOUND and RUN modes.

 Instead of crossfading between chase steps, you can also activate the insert function and then select a memory (FLASH keys [22]/[23]) and crossfade between the last step and the said memory. Also, you can use the STEP key to crossfade between a preset and a memory in an infinite number of steps.

Do the following:

1. Pause a running chase with the INSERT key.
2. Select a memory with one of the FLASH keys.
3. Pull up one or several preset faders (A fader [41] is closed).
4. Fade in the selected preset with the PRESET FLASH key.
5. Crossfade using the STEP key.

6.2.5 Replacing memory steps

To replace a memory step within a chase, do the following:

1. Press the CHASE key [26], select a chase using the DATA wheel (it has to be a memory chase).
2. Press the SOFT B key. Now, go through individual chase steps using the DATA wheel (steps are indicated on the LEDs). Select the step you wish to replace. At the top right-hand side of the display you can observe the storage bank and the location of the current step.
3. Select a new memory that replaces the old one.
4. Press SOFT A for "ENTER". The display moves automatically on to the next step.
5. Replace additional steps as described above or exit the programming procedure by pressing QUIT.

6.2.6 Inserting memory steps

1. Execute steps 1 and 2 as described in chapter 6.2.5. In this case, however, select the step **before** you insert a new step. This and all subsequent steps are moved upward by one step.
2. Activate the shift function (SHIFT key [37]).
3. Select the memory (FLASH key) you wish to insert. The memory is indicated on the LEDs.
4. Press SOFT A for "INSERT".
5. Insert additional steps or exit the programming procedure by pressing QUIT.

6.3 Saving chases as memories (chase to memory)

You can replay up to five chases simultaneously if you store four chases to the storage locations 9 - 12 intended for this purpose. Previously stored data is lost.

1. Press the CTM key [27].



Fig. 6.5: Start menu for CTM programming

2. Select a memory bank using the UP/DOWN keys [19].
3. Select a memory where a chase is to be stored by using one of the four FLASH keys [23]. These keys feature a second (yellow) LED, which blinks in the beat if a chase is stored there.



Fig 6.6: Selection menu for memory, chase number and beat mode

The memory and storage bank numbers you selected are shown at the upper left side of the display.

4. Now, select a chase by turning the DATA wheel. The chase selected is indicated on the control lights, without being visible on the stage.
5. Enter the beat:
 - a) Input via the DATA wheel: keep the SOFT A key pressed and select a time by turning the DATA wheel (up to 10 sec.).
 - b) Automatic control via the bass rhythm: Select the "EXT" option using the SOFT B key [39]. This option lets you control a chase saved in a memory by means of an external audio signal (bass rhythm). The yellow flash key LED beats in the rhythm of the bass sound.
6. Exit the programming procedure by pressing QUIT.

6.3.1 Replaying chases stored as memories (CTM)

Replaying chases stored in memories works exactly the same way as replaying other memories. To replay them on the stage, you have to select the storage bank and pull up the memory fader and the B fader [42].

6.3.2 Previewing and editing CTM

Replay mode and speed

After successfully programming a chase, you can also preview the replay mode and the chase speed, without any of these being visible on the stage. This is particularly useful when you are arranging a light show and don't have time to program a chase in peace.

1. Use the PREVIEW key [21] and select a memory (flash keys 9 - 12) you wish to preview and/or edit.



Fig 6.7: Display "previewing and modifying CTM"

Memory (11) and bank (04) are shown at the top right-hand side of the display.

2. Enter beat measure and replay mode, as described in chapter 6.3 under point 5.
3. Exit the programming sequence by pressing QUIT.

6.4 Previewing chases in live mode

You can use the live mode for chases as well. More detailed information about live mode can be found in chapter 4.5.

To preview chases in live mode, do the following:

1. Activate the live mode by pressing the LIVE switch [30].
2. Press the NUMBER key [48]. The chase is previewed on the stage as long as you keep the key pressed.
3. To quit live mode, simply press the LIVE switch again.

7. ADDITIONAL FUNCTIONS OF THE LC2412

7.1 Locking program mode

To avoid having your setups altered by unauthorized persons, you can block the program mode of your console. There are several blocking functions available.

LOCK PRESET mode

The LC2412 can run only in preset mode. Recalling memories is not possible. Chases can still be replayed.

LOCK PROGRAMMING mode

The console operates normally, but modifying programmed memories or chase steps is possible only after the console is unblocked.

Blocking/unblocking

1. Keep the SOFT A and SOFT B keys pressed and simultaneously press the FLASH key for channel 1 (far left).
2. Now you can select various menus with the DATA wheel.
3. After having selected the desired mode, you can block it/unblock it by pressing the SOFT B key.
4. Exit the programming procedure by pressing QUIT.

7.2 Putting the output on hold

If you want to freeze the current console output while you can make another setup, you can use the HOLD key for this purpose.

1. Press the HOLD key [46].



Fig 7.1: Display "put console output on hold"

2. Implement a modification, as desired (recalling and programming memories and presets is done as described in the respective chapters of this manual).
3. To start a new chase, select this chase as usual by pressing the NUMBER key and turning the DATA wheel. The chase selected will be indicated on the control lights as long as you keep the key pressed.

Releasing "Hold"

To softly crossfade between setups, pull the MAIN fader all the way down and then all the way up. Moving up the fader crossfades between the former setup and the new one.

The hold mode is automatically deactivated when the MAIN fader reaches its upper-most position.

By using the SOFT B key, you can select "CANCEL" in the display, so that you quit a mode. In doing so, the new setup is faded in abruptly.

7.3 Special channels

Both special channels [8] and [9] are well-suited activating effects independently from other settings of the EUROLIGHT LC2412. Fog machines, color changers or disco ball motors are such effects. You can program special activation modes for these effects.

- ▲ **Toggle mode:** The SPECIAL key acts as a switch. Pressing and releasing the key activates the fog machine (or another function). To deactivate it, press and release the SPECIAL key again.
- ▲ **Flash mode:** The SPECIAL key keeps a function active as long as you keep the key pressed. As soon as you let go of the SPECIAL key, the function assigned to this channel is again deactivated.
- ▲ **Kill mode:** Similar to flash mode, a function is activated only as long as the SPECIAL key is kept pressed. However, in addition to this, all other functions are also temporarily disabled.

To program the various modes, do the following:

1. Press the UTILITY 2 key [29].
2. Select the "MORE" option using SOFT B.
3. Select the "SELECT SPECIAL" option on the display by using the SOFT A key [38].
4. SPECIAL 1 key is now labeled with KEY 1 (SPECIAL 2: KEY 2). To change the mode of this key, keep the SOFT A key (for KEY 1; SOFT B for KEY 2) pressed and select the desired option using the DATA wheel.
5. Confirm your selecting with the QUIT key [40] and go back to the main menu.

Special channels are labeled console channels 25 and 26 when assigned to DMX channels (also see chapter 8.2.2.)

7.4 Theater mode

You have the option to store a long sequence (99 steps) so that you can define an **individual** crossfade time for **each** step. This way, you can upload a framework for a complete theater piece into the chase storage, and then expand it with presets and memories. Therefore, think of theater mode as a special kind of chase programming. To let time sequences be flexibly configured, subsequent steps are not controlled automatically or via a sound signal source. Instead, they are triggered individually by hand.

Basic setup of the theater mode

To work in theater mode, the following conditions must be met:

- ▲ Chase control via the internal beat generator (RUN) must be deactivated,
- ▲ Chase control via an external audio signal (SOUND) must be deactivated,
- ▲ MANUAL [54] must be deactivated,
- ▲ INSERT [49] also has to be deactivated.

7.4.1 Activating theater mode

To activate theater mode, do the following:

1. Press the UTILITY 1 key.
2. Using the SOFT B key, select the "MORE" option.
3. After that, you can activate/deactivate theater mode using the SOFT B key.
4. To go back to the main menu, press the QUIT key. When theater mode is active, a "T" is shown in the display.

EUROLIGHT LC2412

7.4.2 Programming fading times in theater mode

Since theater mode presents a special kind of chases, it also uses the menu and chase controls to program steps. Similarly, theater mode sequences are stored as chases.

To program steps for a chase in theater mode, do the following:

1. Activate the theater mode, as described previously.
2. Press the CHASE key [26] and select a chase.
3. Select "LEVEL" or "MEMORY".
4. Modify the desired step or select a memory.
5. Press the SOFT A key for "ENTER".
6. Use the DATA wheel to select the desired fade time (up to 10 sec.). A fade time is displayed if one is already set up.
7. Select "CONT" (continue) option using the SOFT A key. This saves your programming and lets you enter the next step and fade time.
8. Press the QUIT key to go back to the main menu.

☞ Just like with chases and memories, stored fading times can also be stored on a memory card.

7.5 MIDI functions

MIDI commands can be used not only for controlling your instruments but also for controlling the functions of your LC2412. In order to enter commands, you need some kind of sequencing software.

The advantage of using MIDI for programming is that you can program an entire show via MIDI and then simply let it run.

Another simple and clever option lets you transfer existing sequences to a MIDI sequencer via the MIDI OUT connector. A **MIDI implementation chart** as well as the required **information on individual controllers** can be found in this manual's appendix.

7.5.1 Cascading two EUROLIGHT LC2412s

Using MIDI also lets you cascade a second LC2412 to your console. To this end, connect the MIDI OUT connector [58] of the first console (transmitting unit) with the MIDI IN connector [59] of the second LC2412 (receiving unit).

Now, you have to activate the MIDI operating mode in the menu.

Do the following:

1. Press UTILITY 2 key.
2. Select the "MORE" option.



Fig. 7.2: Display "SELECT MIDI"

3. Select the "SELECT MIDI" option.



Fig. 7.3: Display "MIDI channel"

4. Now you can use the DATA wheel to select the MIDI channel used to receive (IN) or to send (OUT). Set up the console to "receive" with the SOFT A key or to "send" with SOFT B key.

All settings implemented on the first console are to be repeated on the second console (e.g. changing storage bank). You can recall presets, memories and chases on the first console (master). In doing so, only control commands are transmitted; the storage banks of the second console (slave) are not modified.

☞ This does not however refer to the **MAIN fader of the second console**. You control the basic illumination level of the receiving console manually.

Programming

When you cascade two light consoles, you must implement the programming of chases and memories in parallel, that is, specific modifications to memory settings are not automatically carried over from one console to the other. Only recall commands are transmitted.

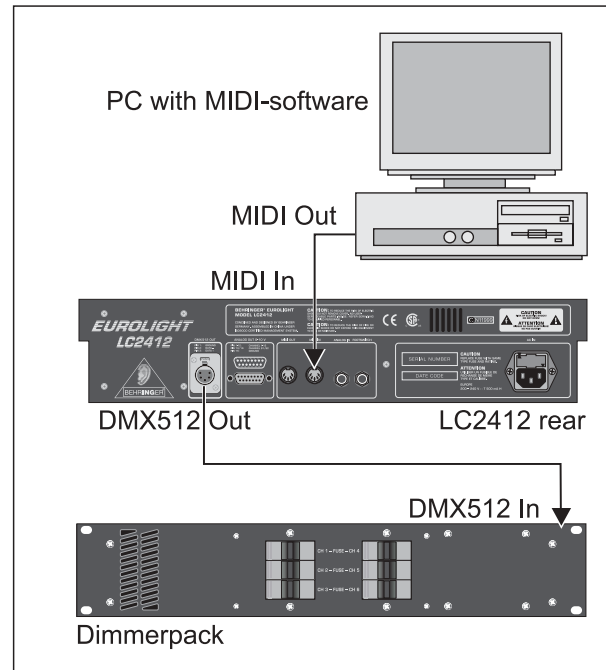

Fig. 7.4: MIDI connection

7.6 Storing data on a memory card

The EUROLIGHT LC2412 is an extremely flexible lighting console, and you can use it for a plethora of possible applications. You can additionally expand the range of its possible applications by storing complete chases and memories onto a memory card (PCMCIA ATA Flash card with 4 MB memory). This feature proves itself particularly useful when you work for various artists on different locations: you will save yourself a lot of time and worries.

- ▲ Insert the memory card into its slot [24]. The LC2412 automatically recognizes the card. To use a new card, you first have to format it. To do that, select "YES".
- ▲ Now you can select one of the 25 storage locations using the DATA wheel. Each of the 25 locations can store the complete set of data containing all console settings.
- ▲ The display shows if the storage location you selected already contains some data or not.
- ▲ With the SOFT A ("SAVE") you can now transmit the data from the console's memory onto the memory card. Pressing SOFT B ("LOAD") transmits the data in the other direction: from the memory card into the memory of the console.

Attention: Storing data on a storage location that already contains some data automatically replaces this data. Similarly, the data on the console's memory is replaced when you transmit the data from the memory card. If you wish to keep this data, make sure to first store it to a memory card.

Since the LC2412 uses its own data format, once you format a memory card on it, you can no longer read this card on a PC!

7.7 Adjusting differing illumination levels

The EUROLIGHT LC2412 lets you adjust illumination levels of various lighting elements to one another so they better match each other. This lets you increase illumination levels of lighting elements whose illumination is insufficient for a specific fader position. In that case, the lighting element whose illumination level was insufficient shines sufficiently brightly.

Program this setting by doing the following:

1. Press UTILITY 1.
2. Select the "MORE" option using SOFT B.
3. Select "SELECT CURVE" using SOFT A.
4. The display now shows in its upper left portion the channel, to its right the status "LINEAR" (standard setting) or "CURVE" (increase). You can now set up the desired setting for this channel by using SOFT A or SOFT B.
5. By using the DATA wheel you can select the desired channel.
6. Complete the programming procedure by pressing QUIT.

7.8 Erasing all settings/ displaying software version

To erase all programmed settings and start from scratch, do the following:

1. Press and keep pressed the SOFT A and SOFT B keys. Then press the FLASH 1 key. The software version is shown in the display. Die Software-Version wird im Display angezeigt. Turn the DATA wheel to get to additional menus and displays (erase memory, lock programming functions, free memory, internal A/D converter condition, self-test).
2. "DELETE ALL" appears in the display, along with the "YES" option. Select this option with SOFT B.



Fig. 7.5: Display "erase all settings"

3. We have created an additional step for your safety. Use the Soft A ("NO") or Soft B ("YES") keys located under the respective options to select one or the other. Selecting "YES" erases all memories and stored chases. In doing so, all settings relevant to the console's functions are reset to their factory settings (SOLO ALL ENABLED, CURVE ALL LINEAR).

8. DIMMER CONTROL

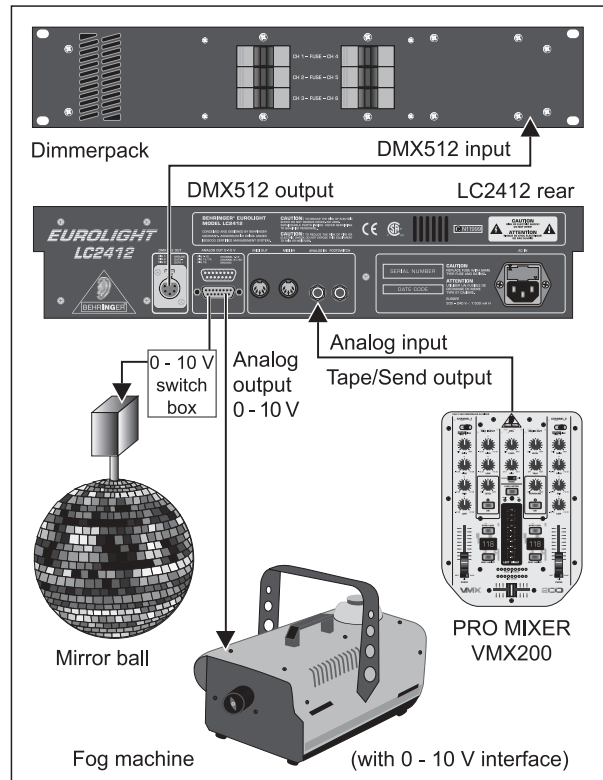

Fig. 8.1: Standard wiring in combination with a dimmer (analog and/or digital control)

8.1 Analog control

In addition to the modern DMX512 interface, you can control your EUROLIGHT LC2412's dimmers using the conventional analog outputs (ANALOG OUT [57], 0 - 10 V DC). However, this lets you control only twelve dimmer channels plus two special channels (only "0 Volts" or "10 Volts").

Whenever possible, use a multicore cable to connect your LC2412 to the dimmer rack, and apportion the cable to individual dimmer packs only once the cable reaches the rack.

8.1.1 Controlling analog dimmers via DMX512

What at first seems like an error is in reality a very useful feature: By using a so-called demultiplexers (demux), you can convert digital commands into analog and therefore control your analog dimmer packs.

The advantage of such a configuration is apparent: you can address the demultiplexer freely, that is, it can for example begin with channel 12 and therefore convert control commands from console channels 13 - 24 into analog signals (DMX channel 0 is controlled one-to-one by console channel 1 and so on, hence the numbering offset). Furthermore, you need only short multicores for analog control, since you can arrange the demultiplexer near the dimmers and send control commands via a single DMX line.

8.2 Digital control via DMX512

8.2.1 Digital control features

The EUROLIGHT LC2412 features a modern digital interface according to the DMX512 Digital Data Transmission Standard For Dimmers And Controllers, that was established in April 1990 by the USITT Engineering Commission (United States Institute for Theatre Technology, Inc.). Since virtually all modern equipment

EUROLIGHT LC2412

uses this standard (even if it is done with partially different plug-in connectors), your EUROLIGHT LC2412 is therefore extremely flexible in how it can be implemented.

A big advantage of digital control is its enormously simplified cabling, since you only need one single cable for transmitting control data. This sets the DMX system apart from its analog counterparts, which need an extra control cable for each individual channel. Another big advantage is made possible by the freely addressable receivers, which is done by means of software. You can therefore save yourself from having to painstakingly lay cables each time you wish to assign a particular dimmer to a different channel. Additional information on this subject can be found in chapter 8.2.2.

Interface format (EIA-485)

The DMX512 standard uses the RS485 interface standard for data transmission, well-known for its impunity to interference. The data are serially transmitted in the asynchron fashion at a transmission rate of 250 kBit/s, successively for each of the connected dimmers (up to 512 channels). The more dimmers are connected, the longer the time interval until the next command on this channel.

It is advisable to limit the number of deployed channels in order to ensure a maximum refresh rate. Therefore, do not use more channels than you actually need.

In combination with the DMX512 standard, you can run up to 32 loads on a single sender (LC2412). One load responds to one DMX512/RS485 receiver, for example, the way it is implemented in a dimmer pack.

If you wish to run more than 32 loads, we recommend using level translators and/or signal splitters.

8.2.2 Assigning DMX channels (softpatch)

Softpatch means: you can assign up to three freely selectable DMX channels to a console channel.

Each of the DMX channels can be assigned to only one fader. Otherwise, contradicting commands would be given with various fader settings.

To make the capabilities of the DMX512 as well as the capabilities of the LC2412 transparent, we have to draw a clear distinction between three different kinds of channels:

Console channels

The channels of your LC2412 (= 24+2 channels) are 26 routes through which you can send commands. This in no way means that you can only control 24 lighting elements.

Dimmer channels (dimmer loops)

Dimmer packs represent the power section of a light control system, comparable to power amplifiers of a PA installation in the audio field. Each dimmer channel is assigned to one DMX channel, that is, it can receive commands from only one channel. For example, if a dimmer loop can handle a maximum power rating of 2.3 kW, you can connect several lamps, spotlights and similar (e.g. 4 x 500 W).

DMX channels

A DMX channel consists out of one digitally transmitted information unit (1 Byte/8 Bit), whereas 256 different information units can be transmitted. These units are transmitted sequentially, that is, channels 0 and upwards on the sender are accounted for, and the respective information units are assigned. The sequence then starts anew at the next channel. In the worst-case scenario (all 512 channels are in use) the refresh rate has the value of 44.1 Hz. You can derive from this that it is advisable to only use as many channels as you actually need.

Since there are 24 channels with adjustable illumination (to each of which 3 DMX channels can be assigned), there is a total of 72 DMX channels that can be laid out. Additionally, there are two special channels, each of which can switch a maximum of 2 DMX channels on and off.

To assign the desired DMX channels to individual console channels (or to preview the assignment of channels), go through the following steps:

1. Press the UTILITY 2 key.



Fig. 8.2: Display "DMX Patch 1"

2. Select "DMX PATCH" using the SOFT A key.



Fig. 8.3: Display "DMX Patch 2"

The console channel is shown in the top left portion of the menu. The connected DMX channels are shown to its right (standard setting is 1:1. Example: Console channel 01 is connected to DMX channel 000, console channel 08 is connected to DMX channel 07, etc.).

The DMX channel is shown in the lower left line; its status is shown next to it (NU = Not Used or USE 1...512). In our example DMX channel 000 is connected to console channel 01.

3. Use the **Flash keys** to first select the **console channel** to which you wish to assign a DMX channel (channels 13 - 24: switch to upper mode, SPECIAL 1 (channel 25) and SPECIAL 2 (channel 26) by pressing **[8]** and **[9]**).
4. Select a **DMX channel** using the **DATA wheel**.

If this DMX channel is already occupied, this will be shown in the display together with the respective console channel number. Select the console channel (FLASH key), and select "OPEN" (SOFT B key). Start again at step 3. Alternatively, you can also select a different DMX channel.
5. Press the SOFT A key ("CONNECT" option) and connect the console channel with the DMX channel. If you wish to connect multiple DMX channels with the same console channel, simply select an additional DMX channel and proceed with the connection as previously described.
6. Use the QUIT key to go back to the main menu.

Connecting channels 1:1 (one-to-one) or disengaging all connections

1. Perform steps 1 and 2, as described under 8.2.3.
2. Press the SHIFT key **[37]**.



Fig. 8.4: Display "DMX Patch 3"

3. Now, select "ALL CLEAR" using the SOFT B key to disengage all connections. Use SOFT A to go back to the standard setting, "ALL 1:1."

9. INSTALLATION

You will need various types of cables for different applications. The following illustrations show you how to lay out these cables. Always use only high-grade cables.

9.1 Cables recommended for DMX512

The cables should be manufactured according to EIA-485 or EIA-422 specifications. Using shielded, twisted, double-stranded data transmission cables is recommended. For example, these are the same cables used for transmitting digital audio data in the AES/EBU format. You can also implement lines with a second wire set, used as a replacement in case of a malfunction.

Using high-quality mic cables is also possible, but their length should be limited to 500 m due to the high cable capacity near a data line.

9.2 Terminal resistor (bus termination)

Using a terminal resistor at the end of the line is an additional condition needed for glitch-free data transmission. To this end, a 120-Ohm resistor is located between both conductors (Pin 2 and Pin 3) in an extra connector. Connect this connector to the DMX out connector of the last piece of equipment in the DMX chain. Shorter connections (up to several meters/roughly 15 ft) do not require termination.

9.3 Pin assignment

9.3.1 DMX512 connections

The DMX512 norm mandates the use of 5-prong XLR connectors. The correct layout is shown in fig. 9.1.

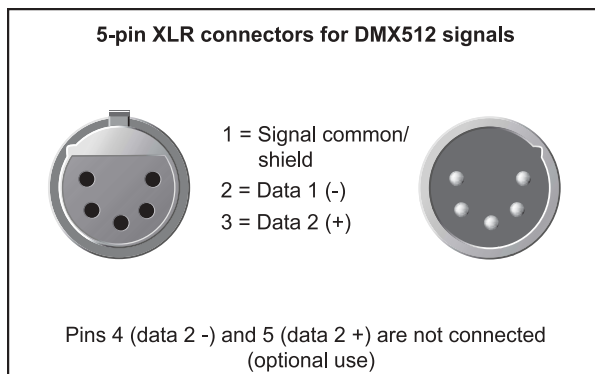

Fig. 9.1: 5-prong XLR connector for DMX512 connections

9.3.2 Sub D connections (analog control)

The following table shows the cable layout of the individual contacts of the sub D connection for analog dimmer control.

Pin No.	Cons. channel
Pin 1	Channel 1
Pin 2	Channel 2
Pin 3	Channel 3
Pin 4	Channel 4
Pin 5	Channel 5
Pin 6	Channel 6
Pin 7	Channel 7
Pin 8	Channel 8
Pin 9	Channel 9
Pin 10	Channel 10
Pin 11	Channel 11
Pin 12	Channel 12
Pin 13	Special 1
Pin 14	Special 2
Pin 15	Ground

Table 9.1: Cable layout of the sub D connection

9.3.3 MIDI connection

Connect to other MIDI equipment or another EUROLIGHT LC2412 by using common MIDI cables. The cables should never be longer than 15 m (45 ft).

9.3.4 Audio connections

To control the EUROLIGHT LC2412 via an audio signal, please use a mono jack connector with standard configuration.

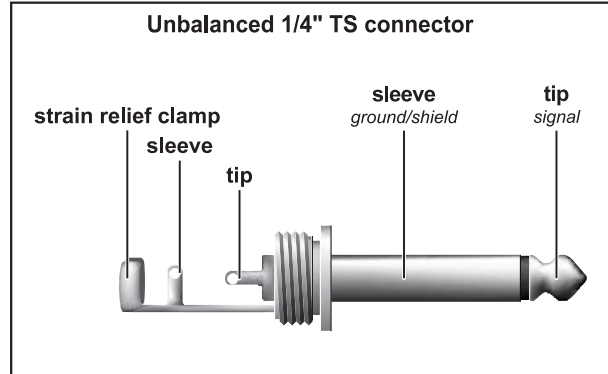

Fig. 9.2: 1/4" TS connector for audio signals

9.3.5 Footswitch

You can use a footswitch to trigger chase steps. This way, both of your hands remain free, letting you control additional settings of your LC2412.

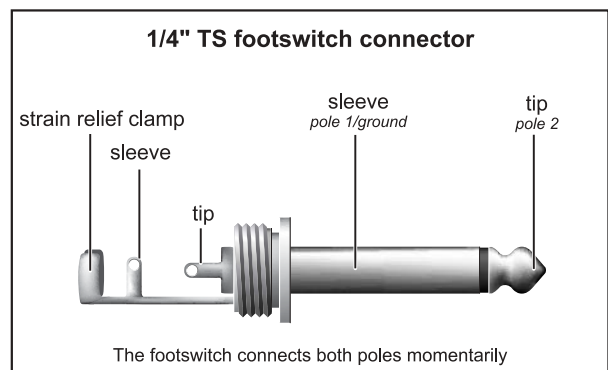

Fig. 9.3: Footswitch connector

As long as a footswitch is kept pressed, the connection of both contacts is closed. Therefore, a footswitch does not act as a switch.

9.4 Rack mounting

Your EUROLIGHT LC2412 is factory-equipped with rack-mounting brackets. You can screw these on to the side of your LC2412 on a per-need basis.

Always make sure that your LC2412 is provided with sufficient ventilation to avoid overheating of the unit!

EUROLIGHT LC2412

10. SPECIFICATIONS

CHANNELS	26 (24 + 2 special switchable channels)
DMX	78 out of 512 DMX channels (max. 3 DMX channels per console-channel)
MEMORIES	max. 120
CHASES	max. 99
Steps	max. 650, up to 99 per chase
INPUTS	
Analog In	1/4" TS mono jack connector, unbalanced
Level	Line level
Footswitch	1/4" TS mono jack connector
MIDI In	DIN 5-pole connector
OUTPUTS	
DMX512 out	XLR 5-pole connector, conforms to the DMX512/1990 standard
MIDI out	DIN 5-pole connector
Analog out	Sub D connector, 15-pole
Level	0/+10 V DC
Min. load impedance	600 Ω
MEMORY CARD	
Format	PCMCIA ATA flash card
Storage capacity	4 MB
Battery type*	3 V lithium battery (e.g. CR2032)
POWER SUPPLY	
Voltage	USA/Canada 120 V~, 60 Hz Europe/U.K./Australia 230 V~, 50 Hz Japan 100 V~, 50 - 60 Hz General export model 120/230 V~, 50 - 60 Hz
Power consumption	27 W
Fuses	100 - 120 V~: T 1 A H 250 V 200 - 240 V~: T 500 mA H 250 V
Mains connection	Standard IEC receptacle
DIMENSIONS/WEIGHTS	
Dimensions (H x W x D)	approx. 4 3/16" x 17 1/2" x 11" (ca. 106 mm x 442 mm x 278 mm)
Weight (net)	approx. 3.8 kg (8.38 lbs.)

* **Caution:** Danger of explosion if the battery is incorrectly replaced. You should only let qualified personnel replace the battery. Replace only with the same type or equivalent.

BEHRINGER continuously strives to assure the highest quality standards possible. Required modifications may be implemented without prior notice. Technical data and the appearance of the unit may deviate from the above values and/or illustrations.

11. MIDI IMPLEMENTATION

MIDI Implementation Chart				
Function	Transmitted	Received	Remarks	Range
Midi Channel	1-16	1-16	-	-
Mode	N	N	-	-
Note Number	N	N	-	-
Velocity	N	N	-	-
After Touch	N	N	-	-
Pitch Bender	N	N	-	-
Control Change	N	N	-	-
0	Y	Y	A Preset Fader 1	0-127
1	Y	Y	A Preset Fader 2	0-127
2	Y	Y	A Preset Fader 3	0-127
3	Y	Y	A Preset Fader 4	0-127
4	Y	Y	A Preset Fader 5	0-127
5	Y	Y	A Preset Fader 6	0-127
6	Y	Y	A Preset Fader 7	0-127
7	Y	Y	A Preset Fader 8	0-127
8	Y	Y	A Preset Fader 9	0-127
9	Y	Y	A Preset Fader 10	0-127
10	Y	Y	A Preset Fader 11	0-127
11	Y	Y	A Preset Fader 12	0-127
12	Y	Y	B Memory Fader 1	0-127
13	Y	Y	B Memory Fader 2	0-127
14	Y	Y	B Memory Fader 3	0-127
15	Y	Y	B Memory Fader 4	0-127
16	Y	Y	B Memory Fader 5	0-127
17	Y	Y	B Memory Fader 6	0-127
18	Y	Y	B Memory Fader 7	0-127
19	Y	Y	B Memory Fader 8	0-127
20	Y	Y	B Memory Fader 9	0-127
21	Y	Y	B Memory Fader 10	0-127
22	Y	Y	B Memory Fader 11	0-127
23	Y	Y	B Memory Fader 12	0-127
24	Y	Y	Speed	0-127
25	Y	Y	X-Fade	0-127
26	Y	Y	Chaser	0-127
27	Y	Y	Main	0-127
28	Y	Y	Main A	0-127
29	Y	Y	Main B	0-127
30	Y	Y	Key Step	>63 ON <64 OFF
31	Y	Y	Key Flash 1	>63 ON <64 OFF
32	Y	Y	Key Flash 2	>63 ON <64 OFF
33	Y	Y	Key Flash 3	>63 ON <64 OFF
34	Y	Y	Key Flash 4	>63 ON <64 OFF
35	Y	Y	Key Flash 5	>63 ON <64 OFF
36	Y	Y	Key Flash 6	>63 ON <64 OFF
37	Y	Y	Key Flash 7	>63 ON <64 OFF
38	Y	Y	Key Flash 8	>63 ON <64 OFF
39	Y	Y	Key Flash 9	>63 ON <64 OFF
40	Y	Y	Key Flash 10	>63 ON <64 OFF
41	Y	Y	Key Flash 11	>63 ON <64 OFF
42	Y	Y	Key Flash 12	>63 ON <64 OFF
43	Y	Y	Bank	0-9
44	Y	Y	Chaser Nr.	0-99
45	Y	Y	Key Channel Flash	>63 ON <64 OFF
46	Y	Y	Key Solo	>63 ON <64 OFF
47	Y	Y	Special 1	>63 ON <64 OFF
48	Y	Y	Special 2	>63 ON <64 OFF
49	Y	Y	Key Manual	>63 ON <64 OFF
50	Y	Y	Sound/Run	0=Step Mode 1=Timer Mode 2=Sound Mode
51	Y	Y	Insert	>63 ON <64 OFF
52	Y	Y	Key Preset	>63 ON <64 OFF
53	Y	Y	Key Memory	>63 ON <64 OFF
Program Change	N	N	-	-
System Exclusive	N	N	-	-
System Common	N	N	-	-
System Real Time	N	N	-	-
Running Status	N	N	-	-

12. WARRANTY

§ 1 WARRANTY CARD/ONLINE REGISTRATION

To be protected by the extended warranty, the buyer must complete and return the enclosed warranty card within 14 days of the date of purchase to BEHRINGER Spezielle Studiotechnik GmbH, in accordance with the conditions stipulated in § 3. Failure to return the card in due time (date as per postmark) will void any extended warranty claims. Based on the conditions herein, the buyer may also choose to use the online registration option via the Internet (www.behringer.com or www.behringer.de).

§ 2 WARRANTY

1. BEHRINGER (BEHRINGER Spezielle Studiotechnik GmbH including all BEHRINGER subsidiaries listed on the enclosed page, except BEHRINGER Japan) warrants the mechanical and electronic components of this product to be free of defects in material and workmanship for a period of one (1) year* from the original date of purchase, in accordance with the warranty regulations described below. If the product shows any defects within the specified warranty period that are not excluded from this warranty as described under § 4, BEHRINGER shall, at its discretion, either replace or repair the product using suitable new or reconditioned parts. In the case that other parts are used which constitute an improvement, BEHRINGER may, at its discretion, charge the customer for the additional cost of these parts.

2. If the warranty claim proves to be justified, the product will be returned to the user freight prepaid.

3. Warranty claims other than those indicated above are expressly excluded.

§ 3 RETURN AUTHORIZATION NUMBER

1. To obtain warranty service, the buyer (or his authorized dealer) must call BEHRINGER (see enclosed list) during normal business hours **BEFORE** returning the product. All inquiries must be accompanied by a description of the problem. BEHRINGER will then issue a return authorization number.

2. Subsequently, the product must be returned in its original shipping carton, together with the return authorization number to the address indicated by BEHRINGER.

3. Shipments without freight prepaid will not be accepted.

§ 4 WARRANTY REGULATIONS

1. Warranty services will be furnished only if the product is accompanied by a copy of the original retail dealer's invoice. Any product deemed eligible for repair or replacement under the terms of this warranty will be repaired or replaced.

2. If the product needs to be modified or adapted in order to comply with applicable technical or safety standards on a national or local level, in any country which is not the country for which the product was originally developed and manufactured, this modification/adaptation shall not be considered a defect in materials or workmanship. The warranty does not cover any such modification/adaptation, irrespective of whether it was carried out properly or not. Under the terms of this warranty, BEHRINGER shall not be held responsible for any cost resulting from such a modification/adaptation.

3. Free inspections and maintenance/repair work are expressly excluded from this warranty, in particular, if caused by improper handling of the product by the user. This also applies to defects caused by normal wear and tear, in particular, of faders, crossfaders, potentiometers, keys/buttons, tubes and similar parts.

4. Damages/defects caused by the following conditions are not covered by this warranty:

▲ improper handling, neglect or failure to operate the unit in compliance with the instructions given in BEHRINGER user or service manuals.

▲ connection or operation of the unit in any way that does not comply with the technical or safety regulations applicable in the country where the product is used.

▲ damages/defects caused by force majeure or any other condition that is beyond the control of BEHRINGER.

5. Any repair or opening of the unit carried out by unauthorized personnel (user included) will void the warranty.

6. If an inspection of the product by BEHRINGER shows that the defect in question is not covered by the warranty, the inspection costs are payable by the customer.

7. Products which do not meet the terms of this warranty will be repaired exclusively at the buyer's expense. BEHRINGER will inform the buyer of any such circumstance. If the buyer fails to submit a written repair order within 6 weeks after notification, BEHRINGER will return the unit C.O.D. with a separate invoice for freight and packing. Such costs will also be invoiced separately when the buyer has sent in a written repair order.

§ 5 WARRANTY TRANSFERABILITY

This warranty is extended exclusively to the original buyer (customer of retail dealer) and is not transferable to anyone who may subsequently purchase this product. No other person (retail dealer, etc.) shall be entitled to give any warranty promise on behalf of BEHRINGER.

§ 6 CLAIM FOR DAMAGES

Failure of BEHRINGER to provide proper warranty service shall not entitle the buyer to claim (consequential) damages. In no event shall the liability of BEHRINGER exceed the invoiced value of the product.

§ 7 OTHER WARRANTY RIGHTS AND NATIONAL LAW

1. This warranty does not exclude or limit the buyer's statutory rights provided by national law, in particular, any such rights against the seller that arise from a legally effective purchase contract.

2. The warranty regulations mentioned herein are applicable unless they constitute an infringement of national warranty law.

* Customers in the European Union please contact BEHRINGER Germany Support for further details.

Technical specifications and appearance subject to change without notice. The information contained herein is correct at the time of printing. The names of companies, institutions or publications pictured or mentioned and their respective logos are registered trademarks of their respective owners. Their use neither constitutes a claim of the trademarks by BEHRINGER® nor affiliation of the trademark owners with BEHRINGER®. BEHRINGER® accepts no liability for any loss which may be suffered by any person who relies either wholly or in part upon any description, photograph or statement contained herein. Colours and specification may vary slightly from product. Products are sold through our authorised dealers only. Distributors and dealers are not agents of BEHRINGER® and have absolutely no authority to bind BEHRINGER® by any express or implied undertaking or representation. No part of this manual may be reproduced or transmitted in any form or by any means, electronic or mechanical, including photocopying and recording of any kind, for any purpose, without the express written permission of BEHRINGER Spezielle Studiotechnik GmbH. BEHRINGER® is a registered trademark.

ALL RIGHTS RESERVED. © 2004 BEHRINGER Spezielle Studiotechnik GmbH,
Hanns-Martin-Schleyer-Str. 36-38, 47877 Willich-Münchheide II, Germany.
Tel. +49 2154 9206 0, Fax +49 2154 9206 4903