

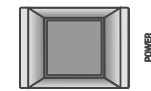

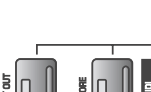







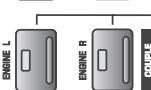
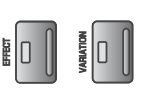
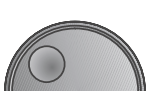

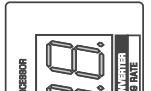
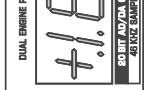
# VIRTUALIZER<sup>®</sup> PRO DSP1000P

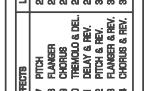
**VIRTUALIZER<sup>®</sup> PRO**  
 100% DIGITAL  
 24-BIT DUAL ENGINE  
 DIGITAL EFFECTS PROCESSOR  
 FULL MIX CONTROL

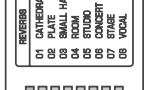
REVERB	SPECIAL EFFECTS	L	DUAL EFFECTS	R
01 CATHEDRAL	09 PERCUSSION	17 PITCH	25 PITCH	REV.
02 PLATE	10 DELAY	18 FLANGER	26 FLANGER	REV.
03 HALL	11 GATED REV.	19 PHASER	27 TREMOLO	REV.
04 ROOM	12 GATED REV.	20 TREMOLO & DEL.	28 TREMOLO	REV.
05 STUDIO	13 REVERSE REV.	21 TREMOLO & DEL.	29 DELAY	REV.
06 CONCERT	14 VOCAL DIST.	22 PITCH & REV.	30 PITCH	ESD
07 VOYAL	15 VOICES	23 PITCH & REV.	31 PITCH	ESD
	16 VOICES	24 CHORUS & REV.	32 CHORUS	ESD

DUAL ENGINE PROCESSOR

+18.8

80 BIT/D/A CONVERTER  
48 KHZ SAMPLE RATE

EFFECT

ENGINE L ENGINE R

EDIT A EDIT B

EQ HI EQ LO

MIX

IN/OUT STORE MIDI

POWER

## User's Manual Bedienungsanleitung

Version 1.0 October 1998



**BEHRINGER<sup>®</sup>**

www.behringer.de



# EG-Declaration of Conformity



INTERNATIONAL GmbH

## acc. to the Directives 89/336/EWG and 73/23/EWG

We, BEHRINGER INTERNATIONAL GmbH  
Hanns-Martin-Schleyer-Straße 36 - 38  
D - 47877 Willich

Name and address of the manufacturer or the introducer of the product on the market who is established in the EC

herewith take the sole responsibility to confirm that the product:

VIRTUALIZER PRO DSP1000P  
Type designation and, if applicable, Article-N°

which refers to this declaration, is in accordance with the following standards or standardized documents:

- |  |  |
|--|--|
| <input checked="" type="checkbox"/> EN 60065 | <input checked="" type="checkbox"/> EN 61000-3-2 |
| <input checked="" type="checkbox"/> EN 55020 | <input checked="" type="checkbox"/> EN 61000-3-3 |
| <input checked="" type="checkbox"/> EN 55013 | <input checked="" type="checkbox"/> EN 55022     |

The following operation conditions and installation arrangements have to be presumed:

acc. to Operating Manual

**BEHRINGER**  
INTERNATIONAL GmbH  
Hanns-Martin-Schleyer-Str. 36-38  
D-47877 Willich, Mühlentide II  
Tel.-Nr. 0 21 54 / 92 06-0  
Fax-Nr. 0 21 54 / 92 06-30

B. Nier, President Willich, 01.10.1998

Name, address, date and legally binding signature of the person responsible

## SAFETY INSTRUCTIONS

**CAUTION:** To reduce the risk of electrical shock, do not remove the cover (or back). No user serviceable parts inside; refer servicing to qualified personnel.



**WARNING:** To reduce the risk of fire or electrical shock, do not expose this appliance to rain or moisture.



This symbol, wherever it appears, alerts you to the presence of uninsulated dangerous voltage inside the enclosure - voltage that may be sufficient to constitute a risk of shock.



This symbol, wherever it appears, alerts you to important operating and maintenance instructions in the accompanying literature. Read the manual.

### DETAILED SAFETY INSTRUCTIONS:

All the safety and operation instructions should be read before the appliance is operated.

#### **Retain Instructions:**

The safety and operating instructions should be retained for future reference.

#### **Heed Warnings:**

All warnings on the appliance and in the operating instructions should be adhered to.

#### **Follow instructions:**

All operation and user instructions should be followed.

#### **Water and Moisture:**

The appliance should not be used near water (e.g. near a bathtub, washbowl, kitchen sink, laundry tub, in a wet basement, or near a swimming pool etc.).

#### **Ventilation:**

The appliance should be situated so that its location or position does not interfere with its proper ventilation. For example, the appliance should not be situated on a bed, sofa rug, or similar surface that may block the ventilation openings, or placed in a built-in installation, such as a bookcase or cabinet that may impede the flow of air through the ventilation openings.

#### **Heat:**

The appliance should be situated away from heat sources such as radiators, heat registers, stoves, or other appliance (including amplifiers) that produce heat.

#### **Power Source:**

The appliance should be connected to a power supply only of the type described in the operating instructions or as marked on the appliance.

#### **Grounding or Polarization:**

Precautions should be taken so that the grounding or polarization means of an appliance is not defeated.

#### **Power-Cord Protection:**

Power supply cords should be routed so that they are not likely to be walked on or pinched by items placed upon or against them, paying particular attention to cords and plugs, convenience receptacles and the point where they exit from the appliance.

#### **Cleaning:**

The appliance should be cleaned only as recommended by the manufacturer.

#### **Non-use Periods:**

The power cord of the appliance should be unplugged from the outlet when left unused for a long period of time.

#### **Object and Liquid Entry:**

Care should be taken so that objects do not fall and liquids are not spilled into the enclosure through openings.

#### **Damage Requiring Service:**

The appliance should be serviced by qualified service personnel when:

- The power supply cord or the plug has been damaged; or
- Objects have fallen, or liquid has been spilled into the appliance; or
- The appliance has been exposed to rain; or
- The appliance does not appear to operate normally or exhibits a marked change in performance; or
- The appliance has been dropped, or the enclosure damaged.

#### **Servicing:**

The user should not attempt to service the appliance beyond that is described in the Operating Instructions. All other servicing should be referred to qualified service personnel.

# VIRTUALIZER PRO

Ultra-high performance Digital Multi-Effects Processor powered by a 24-bit high-speed Digital Signal Processor (DSP)

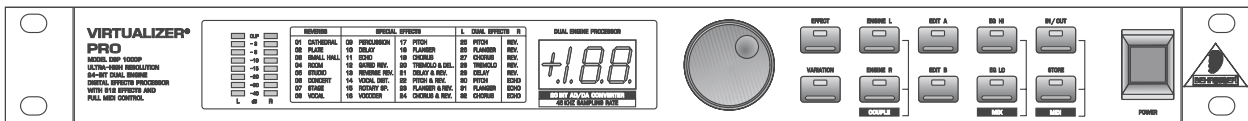

- ▲ “Wave Adaptive Virtual Room” reverb algorithms calculated from precise mathematical room models to give you ultra-natural reverb effects
- ▲ 32 breathtaking Reverb, Chorus, Flanger, Delay (10 sec.), Pitch Shifter, Vocoder, Rotary Speaker effects and more
- ▲ More than 700 effects variations plus two individual parameters and separate low and high EQ section
- ▲ Two digital processing engines give you independent or coupled effects on left and right channels
- ▲ True stereo processing performance allows separation of left and right channels in the stereo field for open-sounding enhancement of the sound sources
- ▲ Free VIRTUALIZER DESIGN software allows for total remote control via PC (download at [www.behringer.de](http://www.behringer.de))
- ▲ 20-bit A/D and D/A converters with 64/128 times oversampling for ultra-high headroom and resolution
- ▲ Internal 24-bit processing with professional 46 kHz sampling rate
- ▲ Servo balanced Inputs and Outputs on gold plated XLR and TRS jack connectors for high signal integrity
- ▲ 100 user preset memories to store programs for instant recall
- ▲ Accurate eight-segment LED level meters simplify level setting for optimum performance
- ▲ “Future-proof” software-upgradeable architecture
- ▲ Full MIDI capability allows real-time parameter control and program selection
- ▲ High-quality components and exceptionally rugged construction ensures long life and durability
- ▲ Internal power supply design for professional application
- ▲ Manufactured under the ISO9000 management system

## FOREWORD

Dear Customer,

Welcome to the team of VIRTUALIZER PRO users and thank you very much for expressing your confidence in BEHRINGER products by purchasing this unit.

It is one of my most pleasant tasks to write this letter to you, because it is the culmination of many months of hard work delivered by our engineering team to reach a very ambitious goal: making an outstanding device better still. The VIRTUALIZER DSP1000 has for quite a long time been a standard tool used by numerous studios and P.A. rental companies. The task to improve one of our best-selling products certainly meant a great deal of responsibility, which we assumed by focusing on you, the discerning user and musician. It also meant a lot of work and night shifts to accomplish this goal. But it was fun, too. Developing a product usually brings a lot of people together, and what a great feeling it is when everybody who participated in such a project can be proud of what we've achieved.

It is our philosophy to share our joy with you, because you are the most important member of the BEHRINGER family. With your highly competent suggestions for new products you've greatly contributed to shaping our company and making it successful. In return, we guarantee you uncompromising quality (manufactured under ISO9000 certified management system) as well as excellent technical and audio properties at an extremely favorable price. All of this will enable you to fully unfold your creativity without being hampered by budget constraints.

We are often asked how we can make it to produce such high-grade devices at such unbelievably low prices. The answer is quite simple: it's you, our customers! Many satisfied customers means large sales volumes enabling us to get better conditions of purchase for components, etc. Isn't it only fair to pass this benefit back to you? Because we know that your success is our success, too!

I would like to thank all people whose help on "Project VIRTUALIZER PRO" has made it all possible. Everybody has made very personal contributions, starting from the designers of the unit via the many staff members in our company to you, the user of BEHRINGER products.

My friends, it's been worth the trouble!

Thank you very much,

A handwritten signature in black ink, appearing to read 'U. Behringer', with a long horizontal flourish extending to the right.

Uli Behringer



# TABLE OF CONTENTS

<b>1. INTRODUCTION .....</b>	<b>7</b>
1.1 The Design Concept .....	7
1.2 Before you begin .....	8
1.3 Control elements .....	8
1.4 The effect algorithms .....	11
1.4.1 Reverb and delay algorithms .....	12
1.4.2 Special effects .....	13
1.4.3 Modulation and pitch shifter effects .....	13
1.4.4 Effect algorithm combinations (multi-effects programs) .....	14
1.4.5 Dual-mode effects algorithms .....	14
<b>2. OPERATION .....</b>	<b>16</b>
2.1 Effects structure .....	16
2.2 Selecting presets .....	16
2.3 Editing programs .....	17
2.4 Saving programs .....	17
2.5 MIDI control .....	17
<b>3. APPLICATIONS .....</b>	<b>19</b>
3.1 Level setting .....	19
3.2 Using the VIRTUALIZER PRO in the aux bus .....	19
3.3 Using the VIRTUALIZER PRO in the insert path .....	20
3.4 Using the VIRTUALIZER PRO as an effects device for instruments .....	21
3.5 Using the VIRTUALIZER PRO in a MIDI system .....	22
3.6 Saving data via MIDI .....	22
<b>4. TECHNICAL BACKGROUND .....</b>	<b>22</b>
4.1 Digital Audio Processing .....	22
4.2 Reverberation and reflection .....	24
4.2.1 Reverberation chambers .....	25
4.2.2 Spring and plate reverb .....	25
4.2.3 Digital reverb .....	26
<b>5. INSTALLATION .....</b>	<b>27</b>
5.1 Rack mounting .....	27
5.2 Mains connection .....	27
5.3 Audio connections .....	27
5.4 MIDI connections .....	29
5.5 Operating Level switch .....	29
<b>6. APPENDIX .....</b>	<b>30</b>
6.1 Parameter overview .....	30
6.2 Delay values / increments for presets 10 and 11 .....	31
6.3 MIDI-implementation .....	32
6.4 Default settings .....	33
6.5 Specifications .....	34
<b>7. WARRANTY .....</b>	<b>35</b>

# 1. INTRODUCTION

The BEHRINGER VIRTUALIZER PRO is a member of the latest generation of multi-effects processors. To generate reverberation that is very natural in character, we at BEHRINGER developed innovative virtual acoustics algorithms which allow for computing all room and reverb parameters with absolute pro-level quality and a highly natural sound character.

Since its introduction in the early 80's, artificial digital reverb has been an indispensable standard tool for studio and live applications. Before, professional reverberation could only be produced by using bulky and expensive reverberation plates. With the rapid development of digital technology it has become possible to drastically reduce the price of a good reverb unit, so it is anything but unusual today to find at least one digital reverb device in the racks of P.A. rental companies and recording studios. Owing to their system structure, most digital effects processors are also capable of generating other effects in addition to reverberation. These multi-effects processors enable the user to easily produce a maximum variety of effects featuring pro-level audio quality.

With the BEHRINGER VIRTUALIZER PRO you have purchased a very powerful multi-effects processor which offers both first-class reverb sounds and various other effect algorithms. Although you will find a high number of effect types - 32 newly developed effect types with more than 700 variations - the VIRTUALIZER PRO can be operated easily and intuitively with its logically structured user interface. The VIRTUALIZER PRO gives you well-known classic effects such as reverb, delay and chorus, plus a broad spectrum of additional programs including such extraordinary effects as "Vocal Distortion", "Rotary Speaker Simulation" or "Vocoder". To be able to fully exploit these effects as well as the other features of the BEHRINGER VIRTUALIZER PRO's innovative virtual acoustics technology, we recommend that you read this user's manual carefully.

 **The following operational manual will introduce you to the BEHRINGER VIRTUALIZER PRO and its various functions. After reading the manual carefully, make sure it is always on hand for future reference.**

## 1.1 The Design Concept

Despite extensive computing work which is done in the DSP1000P by a "dual-engine" 24-bit processor, the VIRTUALIZER PRO can be operated easily and conveniently. All parameter edits are performed with the jog wheel (rotary control). 100 presets are available to store user-defined programs.

However, the DSP1000P is by no means limited to excellent reverb and delay programs. In addition to the simulation of classic plate reverbs, the VIRTUALIZER PRO gives you extraordinary modulation effects (such as chorus and flanger), plus a few special-purpose variants, e.g. a musical pitch shifter as well as tremolo and rotary speaker simulations. With the vocoder and vocal distortion effect programs, you even have ultra-modern effects available that the DSP1000P generates with absolute realism.

A very special feature are the high-low filters which can be freely edited and directly selected in each preset. With these filters you can fine-tune the sound of your presets to match any given room characteristics - a time saving feature especially for live applications, where every second counts. The VIRTUALIZER PRO not only features a logical and easy-to-operate user interface but also highly impressive specifications. With its complete MIDI implementation the DSP1000P can be integrated in any MIDI system. A MIDI software editor (soon available) enables you to program the VIRTUALIZER PRO from your personal computer, and the MIDI interface allows for transmitting data from the DSP1000P and store them on an external storage medium. For example, you can use sys-ex dumps to send all presets and settings to your sequencer program and reload them from there whenever you want.

The philosophy behind BEHRINGER products guarantees a no-compromise circuit design and employs the best choice of components. Top-quality 20-bit AD/DA converters which belong to the best components available owing to its outstanding specifications and excellent sonic characteristics. Two 24-bit DSPs are used as the heart of the VIRTUALIZER PRO. These perform the precise calculations needed for the processing of the complex algorithms. Additionally, the VIRTUALIZER PRO uses high quality resistors and capacitors with very tight tolerances, high-grade switches, low-noise operational amplifiers (type 4580) as well other selected components

The VIRTUALIZER PRO DSP1000P uses SMD technology (Surface Mounted Device). These subminiature components known from aerospace technology allow for an extreme packing density, plus the unit's reliability could be improved. Additionally, the unit is manufactured in compliance with a ISO9000 certified management

system.

## 1.2 Before you begin

Your BEHRINGER VIRTUALIZER PRO was carefully packed in the factory and the packaging was designed to protect the unit from rough handling. Nevertheless, we recommend that you carefully examine the packaging and its contents for any signs of physical damage, which may have occurred in transit.

**👉 If the unit is damaged, please do not return it to us, but notify your dealer and the shipping company immediately, otherwise claims for damage or replacement may not be granted. Shipping claims must be made by the consignee.**

The BEHRINGER VIRTUALIZER PRO fits into one standard 19" rack unit of space (1 3/4"). Please allow at least an additional 4" depth for the connectors on the back panel.

**👉 Be sure that there is enough space around the unit for cooling and please do not place the VIRTUALIZER PRO on high temperature devices such as power amplifiers etc. to avoid overheating.**

The mains connection of the VIRTUALIZER PRO is made by using a mains cable and a standard IEC receptacle. It meets all of the international safety certification requirements. Please make sure that all units have a proper ground connection.

**👉 Before you connect your VIRTUALIZER PRO to the mains, please make sure that your local voltage matches the voltage required by the unit! (see chapter 5 for details)**

**👉 Please ensure that only qualified persons install and operate the VIRTUALIZER PRO. During installation and operation the user must have sufficient electrical contact to earth. Electrostatic charges might affect the operation of the VIRTUALIZER PRO!**

As a standard the audio inputs and outputs on the BEHRINGER VIRTUALIZER PRO are fully balanced. If possible, connect the unit to other devices in a balanced configuration to allow for maximum interference immunity. The automatic servo function detects unbalanced connections and compensates the level difference automatically (6 dB correction).

The MIDI links (IN/OUT/THRU) are made over standardized DIN patch cords. The data communication is isolated from ground by opto-couplers.

## 1.3 Control elements

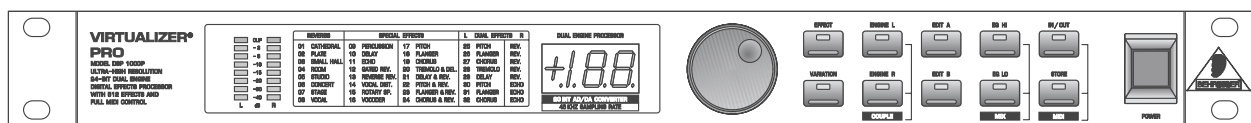

Fig. 1.1: VIRTUALIZER PRO front panel

The BEHRINGER VIRTUALIZER PRO is equipped with ten parameter keys, one jog wheel (rotary control), an LED display and a power switch. Each of the two fully independent channels can be monitored with an 8-stage LED meter.



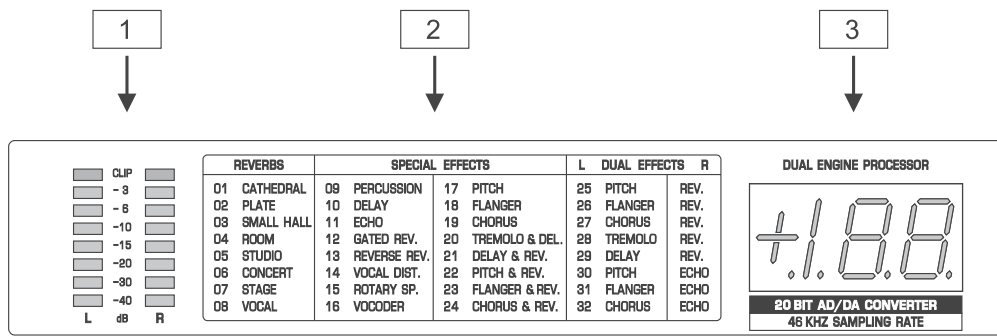

Fig. 1.2: Display section of the DSP1000P

- 1 The two LED chains display the input signal level in dB, referenced to the internal digital maximum.
- 👉 Please note that the nominal level of the VIRTUALIZER PRO can be selected with the +4 dBu / -10 dBV switch located on the back panel.
- 2 The EFFECT TABLE gives you an overview of the 32 different effect algorithms.
- 3 After power-up, the LED display shows the number of the preset last used. This clearly legible, 2½ digit numeric display has plus/minus indicators to show that parameters are being incremented or decremented in Edit mode.

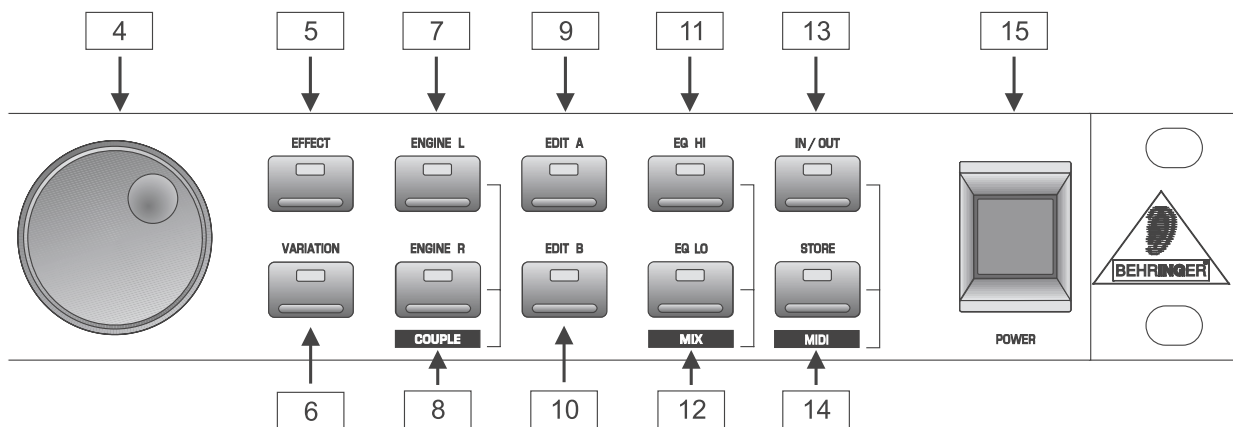

Fig. 1.3: Function keys and jog wheel

- 4 With the JOG WHEEL, a continuous rotary control, you can freely edit the selected parameters. Turn the wheel clockwise to increase the values, or counterclockwise to reduce them.
- 👉 As long as none of the edit functions to the right of the jog wheel have been selected, you can use the wheel to select a program directly, which is shown by a dot lit up in the display. While this dot is on, you can select a program though its settings will not take immediate effect. When the jog wheel has not been touched for at least one second, the LED in the display disappears and the program will be loaded.
- 5 Use the EFFECT key to directly select one of the 32 basic effect algorithms with the jog wheel.
- 👉 Whenever a new algorithm is selected, all parameters are reset to default values. See table 6.4 in the appendix.

- 6 The *VARIATION* key allows you to select an alternative variation of each effect algorithm activating a different setup of the numerous internal effect parameters. With this feature you can extensively manipulate the effect sound within a very wide range.
- 7 Use the *ENGINE L* key to select the left audio channel for true-stereo effects. Many effects may have different *ENGINE L* and *ENGINE R* parameters available through *EDIT A* and *EDIT B*. Where to find which parameter can be seen from the parameter list printed on the top of the unit.
- 8 Use the *ENGINE R* key to select the right audio channel (similar to point 7: *ENGINE L*). If you wish to process the left and right audio channels simultaneously (*COUPLE* mode), press both Engine keys together. In *COUPLE* mode both Engine LEDs light up. Whenever you edit one of the two audio channels and then switch to *COUPLE* mode, the parameters of the active channel will be copied to the other; i.e if you press *ENGINE L* before *R*, left will be copied to right. When parameters cannot be adjusted separately in a specific algorithm, the DSP1000P switches to *COUPLE* mode automatically.
- 9 In each preset you can edit at least two parameters in addition to the preset variation. Use the *EDIT A* key to select the first parameter. The exact parameter assignment can be seen from the parameter list printed on top of the unit.
- 10 The *EDIT B* key allows you to modify the second parameter as required.
- 11 To give your programs the finishing touch, the VIRTUALIZER PRO incorporates two filters. Use the *EQ-HI* key to raise or lower the high-frequency portions of the effect program.
- 12 The *EQ-LO* key activates a filter which processes the low-frequency portions of your preset.
- 13 The *IN/OUT* key enables you to bypass the DSP1000P. The green LED lights up as soon as the VIRTUALIZER PRO is activated. Depending on the Mix mode adjusted (see below), this key can also be used to activate the Mute function. Additionally, the green LED starts flashing whenever MIDI data are being received.
- 14 Use the *STORE* key to save the edited program to a user preset as shown in the display. 100 user presets are available on the DSP1000P. Press the key once to select a memory location (number), then press it again to store the preset.
- 15 Use the *POWER* switch to switch the VIRTUALIZER PRO on or off.

### Key combinations

To protect the DSP1000P against user errors, three important edit commands have been implemented as a series of key combinations. For example, in normal operating modes, the presets cannot be reset to their factory defaults, so as to secure your own programs as safely as possible. Please proceed as follows to reinitialize the preset default settings:

- ▲ **Keep the keys *EFFECT* and *STORE* pressed before powering up the VIRTUALIZER PRO. Then switch on the DSP1000P and keep the two keys pressed for about two seconds. The program numbers are counted up and reset to their original default settings.**

The VIRTUALIZER PRO provides two methods to mix the input and the effect signals (*External Mix* and *Internal Mix* modes). Select *External Mix* mode to use the DSP1000P with a mixing console: in this mode all presets are set to 100% effect intensity, i.e. you can use the aux return busses of your console to add the processed signal to the original signal. In *External Mix* mode the *IN/OUT* key is used to bypass the unit. Here's how to enter *External Mix* mode:

- ▲ **With the unit switched on, press the Mix mode key combination, i.e. the keys *EQ LO* and *EQ HI*. The VIRTUALIZER PRO enters Mix mode. When the display shows two dashes, the DSP1000P is in *External Mix* mode, and when a figure is displayed, *Internal Mix* mode is selected. To toggle between the two modes, simply press both *EQ* keys for about 2 seconds.**

In *Internal Mix* mode you can use the jog wheel to freely select the effect intensity in each preset within a range from 0% to 100%, a highly useful feature, for instance, to insert the DSP1000P in the effect loop of a guitar amp. Good results can be achieved with settings between 20% and 50%.

Another key combination can be used to enter MIDI mode. With the VIRTUALIZER PRO switched on, proceed as follows:

- ▲ **Keep the keys *IN/OUT* and *STORE* pressed for about two seconds, the DSP1000P automatically enters MIDI mode. Use the *IN/OUT* key to step through the various MIDI parameters. Press**

any other key to quit MIDI mode.

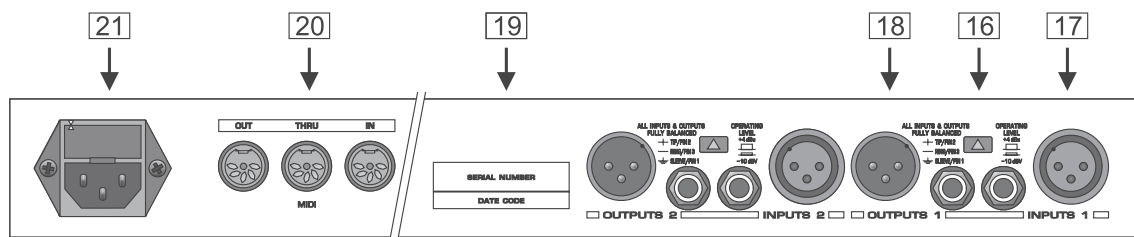

Fig. 1.4.: Back panel connectors and control elements

- 16 Use the *OPERATING LEVEL* switch to adapt the VIRTUALIZER PRO to different operating levels. You can select a -10 dBV semi-pro level used for home recording and a +4 dBu level used in professional studios. The level indicators on the front panel are automatically adapted to read the selected nominal level, i.e. an optimum operating range of the meters is always guaranteed.
- 17 These are the VIRTUALIZER PRO's analog *INPUTS*. The VIRTUALIZER PRO has both XLR and jack inputs and outputs. Each XLR and jack set are wired parallel and can be used either balanced and unbalanced.
- 18 These are the VIRTUALIZER PRO's analog *OUTPUTS*. Also on balanced or unbalanced XLR or TRS jacks.
- 19 These are the VIRTUALIZER PRO's MIDI connectors (*MIDI OUT / THRU / IN*). Total remote control is possible via MIDI.
- 20 Please take the time to make a note of the *SERIAL NUMBER* in the space provided on the enclosed Warranty Registration Card. Put the instruction manual in a safe place and return the completed Warranty Registration Card to us within 14 days of purchase, making sure that the dealer stamp has been acquired (certain countries only).
- 21 This is the *MAINS CONNECTOR / FUSE HOLDER / VOLTAGE SELECTOR*. Before you connect the unit, please make sure that the displayed voltage corresponds to your Mains supply. Please note that the AC voltage selection is defined by the position of the Fuse Holder. If you intend to change the operating voltage, remove the Fuse Holder and turn it by 180 degrees before you reinsert it. Matching the two markers monitors the selected voltage. Please note that, depending on the mains voltage supplied to the unit, the correct fuse type and rate must be installed (see chapter 6.5 "SPECIFICATIONS"). Please use the enclosed mains cable to connect the unit to the mains power supply.

**Please note that not all appliances can be used with different mains voltage ratings. Please check the description on the back of the unit and the box.**

## 1.4 The effect algorithms

In a digital effects device all effect programs are based on algorithms computed by a Digital Signal Processor (DSP). How does this work? A DSP can perform an enormous number of binary computations in a minimum amount of time. The binary computations used to generate an effect as part of a program are determined by a so-called algorithm which represents a rule for computing numerical values that are exactly specified for each effect type. For example, reverb algorithms differ from chorus algorithms in their programming. Plainly speaking: each effect is based on a specific algorithm which processes the input signal (converted from analog to digital before). All of this work is done by the DSP. Once the effect has been generated and added to the input signal, the digital music signal is converted back to analog by means of a D/A converter.

The VIRTUALIZER PRO permits the change of as many as five parameters which influence the sound in different ways. This means that for some algorithms the parameters are chosen by using key combinations with **ENGINE L** and **ENGINE R**. In these cases a combination of **ENGINE L** and **ENGINE R** with the **EDIT A** and **EDIT B** key will not mean that only one channel is affected. The combination **EDIT A – ENGINE L** is a different parameter than the combination **EDIT A – ENGINE R**, these parameters will be changed on both channels. With a reverb effect (like PRG 1) **Edit B – ENGINE R** does not mean that the right audio channel is processed, but that the second **Edit B** parameter (with Prg.1: High Multiply) is adjusted.

The only exception is the DUAL MONO (PARALLEL) effects, which produce another effect in the left channel

from the right channel. In those cases **EDIT B – ENGINE L** or **EDIT B – ENGINE R** means that you select **EDIT B** and the left or right engine. If we only state **EDIT B** for instance then the selection of the left or right engines does not play a role.



### 1.4.1 Reverb and delay algorithms

- 1 **Cathedral:** Reverb program that generates long and dense reverberation, much like the natural reverb ambience found in churches or cathedrals. Particularly suitable for solo instruments and voices. **Variation** modifies the decay time, **EDIT A** adjusts the differences between tiled and angular walls (diffusion), while **EDIT B – ENGINE L** governs the early reflections and **EDIT B – ENGINE R** the brilliance of the reverb signal.
- 2 **Plate:** The sound of early reverb plates. The decay time can be set from 0-9 s using **VARIATION**. **EDIT A** determines the pre-delay by changing the perceived size of the room, **EDIT B** uses **ENGINE L** to enhance the stereo image and **ENGINE R** to modify the room brilliance. A classic reverb program for drums and solo voices.
- 3 **Small Hall:** Simulation of a small, highly reverberating hall. Use short reverb times (**VARIATION**) to process drum instruments or medium reverb times to enhance wind instruments. **EDIT A** controls diffusion, **EDIT B** early reflections (**ENG. L**) and stereo width (**ENG. R**).
- 4 **Room:** You can clearly hear the walls of this room as they are reflecting the sound. Their characteristics can be changed with **EDIT B** (from reflective (tiles, marble) to absorbent (carpets, curtains). Use **VARIATION** (reverb time / room size) to create any room type—from small store rooms to large living rooms. **EDIT A** governs the pre-delay. A useful program for reverb that isn't directly noticeable (rap, hip hop vocals) or to make dry recordings of instruments sound natural again. Very all-round effect.
- 5 **Studio:** Middle to large rooms that can be modified in their wall characteristics (**EDIT B, ENG. R**), early reflections (**EDIT B – ENG. L**), position of sound source (= pre-delay: **EDIT A**) and size (**VARIATION**). Creates a natural and multipurpose sound.
- 6 **Concert:** Use **VARIATION** (reverb time) to create a small theater or large concert hall, determine the distance to the stage (= pre-delay: **EDIT A**), the distance to neighboring walls (= early reflections: **EDIT B – ENG. L**) and their structure (= diffusion: **EDIT B – ENG. R**).
- 7 **Stage:** Wonderful reverb, for example, to provide keyboard pads or acoustic guitars with width and depth (**EDIT B – ENG. R = stereo width**), and to make them sound fresher (**EDIT B – ENG. L = brilliance**). Additionally, you can set the reverb time with **VARIATION** and the diffusion with **EDIT A**. Designed for live applications and mixdown.
- 8 **Vocal:** Rich and dense reverb with middle reverb times (**VARIATION**) giving solo voices their finishing touch. **EDIT A** controls pre-delay, **EDIT B – Eng.L** early reflections and **EDIT B – ENG. R** brilliance.
- 9 **Percussion:** This dense reverb is characterized by pronounced early reflections which make it very suitable for dynamic signals (drums, percussion, slap bass, etc.). Apart from diffusion (**EDIT A**) and reverb time (**VARIATION**) you can create interesting effects using the separately adjustable decay time of high-frequency portions (**EDIT B**), which make the reverb more, or less audible.
- 10 **Stereo Delay:** Here, the input signal is delayed by as much as 5.1 s. Use **VARIATION** for a rough setting from 0 ms to 5.1 s. Use **EDIT A** to adjust the delay time in milliseconds (in steps of 5 ms up to **VARIATION** 6, then 10 ms). **EDIT B** determines the amount of effect signal that is fed back to the effect (input signal is repeated several times with decaying intensity). The maximum feedback is limited to avoid feedback loops.
- 11 **Stereo Ping-Pong Echo:** Much like the delay effect, echo repeats the input signal with decaying intensity. However, here the echoes lose brilliance with each repetition, which simulates the trendy “vintage” effect produced by tape echo units that were widely used in the pre-digital era. Additionally, the “reflections” are alternatingly routed to the left and right channels so as to produce a kind of stereo effect.

- 12 Gated Reverb:** Phil Collins' song "In the air tonight" made this effect famous: a reverb is cut off abruptly after a certain time. **VARIATION** determines the cutoff time, **EDIT A** controls the reverb intensity and **EDIT B** the threshold above which reverb comes in (a kind of noise-gate before the reverb signal input).

 **If used for rhythmical signals (snare) adjust the length so that the reverb is cut off just before the next quarter note (e.g. bpm = 120, quarter note = 0.5 s, length less than 0.5 s).**

- 13 Reverse Reverb:** A reverb program with an inverted amplitude envelope, i.e. the effect starts softly and then increases in volume. This effect used to be created by playing a tape in reverse direction, recording the reverb signal, and then playing back the tape in forward direction again, with the result that the reverb signal was played back before the actual input signal. **VARIATION** controls the length of the signal, **EDIT A** the delay, and **EDIT B** the threshold above which the effect responds.



### 1.4.2 Special effects

- 14 Vocal Distortion:** A clearly up-to-date program for lo-fi effects applied to vocals or drum loops, combined with a delay. **VARIATION** determines the degree of distortion in 32 steps, **EDIT A** controls the delay from 0 to 200 ms. **EDIT B** governs the delay mix. As a little extra the distortion circuit also includes an LFO-controlled notch filter which audibly wanders back and forth with maximum distortion (**VARIATION** 32).
- 15 Rotary Speaker:** Simulation of the legendary rotary speaker effect produced by speakers rotating at slow/fast speed within a bulky cabinet. The effect uses the physical principle known as Doppler effect. **VARIATION** changes the frequency response (higher value = less high frequencies). Settings of 30 and higher also simulate the tube distortion that was produced by the original cabinets in the 70's. **EDIT A** controls the speed of the horn-loaded speaker (treble range), **EDIT B** that of the rotor (bass range).
- 16 Vocoder:** Another all time favorite that has gained new popularity during the disco music renaissance of the past few years ("Around the World" by Daft Punk or "California" by TuPac). Basically, a control signal (usually vocals) in the right channel is used to modulate another signal in the left (e.g. synth sound), which sounds as if the synth was talking (robot voice). **VARIATION** determines the type of vocoder, **EDIT A** the degree of distortion, and **EDIT B** the effect sensitivity.



### 1.4.3 Modulation and pitch shifter effects

- 17 Pitch:** This effect transposes the input signal either in cents (**EDIT A** — producing a light detune effect) or semi-tones (**EDIT B** — up/down to one octave). Settings can be made independently for both channels, so as to create harmonies or simply to widen the sound of a single voice. The pitch effect can also be used to produce a cartoon character type voice effect.
- 18 Flanger:** An LFO constantly modulates the effect signal's pitch by a few cents up and down. The LFO speed is controlled by **VARIATION**, the amount of pitch modulation by **EDIT A**, the portion of the effect signal fed back to the effect block (=feedback) can be determined with **EDIT B**. By the way, you can separately control the channels' modulation depth and feedback, which allows for highly complex modulations. Flanger effects are primarily used for guitars, but there are also lots of other useful applications: voices, cymbals, bass, remixes, etc.
- 19 Chorus:** Though similar to the flanger, chorus uses a delay function instead of feedback. Combined with the pitch shifting feature, the delay produces a very pleasant detune effect. **VARIATION** changes the modulation frequency, **EDIT A** controls the delay and **EDIT B** the modulation depth. Chorus effects are used so often and in such a variety of applications that any recommendation would mean a limitation of their use.

- 19 Tremolo & Delay:** Since trip hop has become trendy, this effect — originally found in guitar amps — is used to produce a more or less fast and intensive variation of volume (with an additional panorama effect included in the DSP1000P). The modulation speed is controlled with **VARIATION**, the intensity with **EDIT A**, and the panning rhythm with **EDIT B**. This algorithm belongs to the group of multi-effects programs and also includes a delay effect which can be adjusted with **EDIT A - ENG. R** (= delay time from 0 to 340 ms in steps of 5.4 ms) and **EDIT B - ENG. R** (= feedback).



#### 1.4.4 Effect algorithm combinations (multi-effects programs)

Effect algorithms nos. 20 through 24 are multi-effects algorithms combining various effect types with, for instance, a reverb algorithm, and can hence be used simultaneously. For example, effect #24 allows you to chorus a lead guitar sound and at the same time add some room reverb.

- 20 Tremolo & Delay:** This effect was originally meant for guitar but has become very popular with the emergence of trip-hop. A variable, both in intensity and speed, variation of the volume, with additionally a panning effect. Determine the speed of the modulation you with **VARIATION**, the intensity with **EDIT A - ENGINE L** and the Panning speed with **EDIT B - ENGINE L**. This algorithm belongs to the group of the multi-effect programs and is combined with a delay. Delay time is set with **EDIT A - ENGINE R** ranging from 0 to 630 ms (10 ms increments) feedback is set with **EDIT B - ENGINE R**.
- 21 Delay & Reverb:** Probably the most popular combination used for vocals, solo guitars, etc. With **ENGINE L** you can adjust delay time (**EDIT A - ENGINE L**) and feedback (**EDIT B - ENGINE L**). **EDIT A - ENGINE R** controls decay time and **EDIT B - ENGINE R** reverb mix. The program uses a Bright Room reverb which can be used for a variety of applications. **VARIATION** changes the Delay Mix.
- 22 Pitch & Reverb:** Use **ENGINE L** to transpose the pitch shifter (**EDIT A** = cents; **EDIT B** = semi-tones), and **ENGINE R** to control the reverb (Bright Room).
- 23 Flanger & Reverb:** The flanger can be controlled in its modulation depth (**ENG. L – EDIT A**) and feedback (**ENG. L – EDIT B**), the reverb in its decay time (**ENG. R – EDIT A**) and mix amount (**ENG. R – EDIT B**). You can also adjust the modulation frequency with the **VARIATION** parameter.
- 24 Chorus & Reverb:** This algorithm combines the popular chorus effect. Controllable parameters: modulation frequency (**VARIATION**), modulation delay (**ENG. L – EDIT A**) and depth (**ENG. L – EDIT B**) with the reverb from programs nos. 21-23.



#### 1.4.5 Dual-mode effects algorithms

Unlike multi-effects programs, dual-mode programs (nos. 25 through 32) have their effects split up and sent separately to the two audio channels (left/right). For example, you can route a flanger to the VIRTUALIZER PRO's left channel, while using a reverb (effect #26) for the right channel. In this way, you can use the DSP1000P's dual-engine processor as if it were two separate mono effects devices.

- 25 Pitch/Reverb:** Here, you have a pitch shifter in the left channel (= **Engine**) with the usual edit options, and a reverb in the right channel, which can be controlled in its length (**EDIT A**) and high-frequency content (**EDIT B**).
- 26 Flanger/Reverb:** left channel = flanger, modulation speed is controlled by **VARIATION**, delay by **ENG. L - EDIT A** and depth by **ENG. L - EDIT B**. Right channel = reverb, with reverb time controlled by **ENG. R - EDIT A** and brilliance with **ENG. R - EDIT B**.
- 27 Chorus/Reverb:** Left channel = chorus, modulation speed is controlled by **VARIATION**, delay by **ENG. L - EDIT A** and feedback by **ENG. L - EDIT B**. Right channel = reverb, with reverb time controlled by **ENG. R - EDIT A** and brilliance with **ENG. R - EDIT B**.
- 28 Tremolo/Reverb:** Left channel = tremolo, modulation speed is controlled by **VARIATION**, delay by **ENG. L - EDIT A** and feedback by **ENG. L - EDIT B**. Right channel = reverb, with reverb time controlled by **ENG. R - EDIT A** and brilliance with **ENG. R - EDIT B**.

- 29 Delay/Reverb:** normal delay left, delay time can be set from 0 to 630 ms with **ENG. L - EDIT A** in 10 ms steps and feedback by **ENG. L - EDIT B**. Right channel = reverb, with reverb time controlled by **ENG. R - EDIT A** and brilliance with **ENG. R - EDIT B**. reverb right.
- 30 Pitch/Echo:** Left channel a pitch shifter. **ENG. L - EDIT A** = shift in cents, **ENG. L - EDIT B** = semitones. Right channel = echo effect, delay time can be set from 0 to 630 ms with **ENG. R - EDIT A** in 10 ms steps and feedback by **ENG. R - EDIT B**.
- 31 Flanger/Echo:** Left channel a flanger, modulation frequency is controlled with VARIATION, depth with **ENG. L - EDIT A** and feedback with **ENG. L - EDIT B**. Right channel = echo effect, delay time can be set from 0 to 630 ms with **ENG. R - EDIT A** in 10 ms steps and feedback by **ENG. R - EDIT B**.
- 32 Chorus/Echo:** Left channel a chorus effect, modulation frequency is controlled with VARIATION, modulation delay with **ENG. L - EDIT A** and modulation depth with **ENG. L - EDIT B**. Right channel = echo effect, delay time can be set from 0 to 630 ms with **ENG. R - EDIT A** in 10 ms steps and feedback by **ENG. R - EDIT B**.



**For an overview of all program parameters see the table in section 6.1.**



## 2. OPERATION

### 2.1 Effects structure

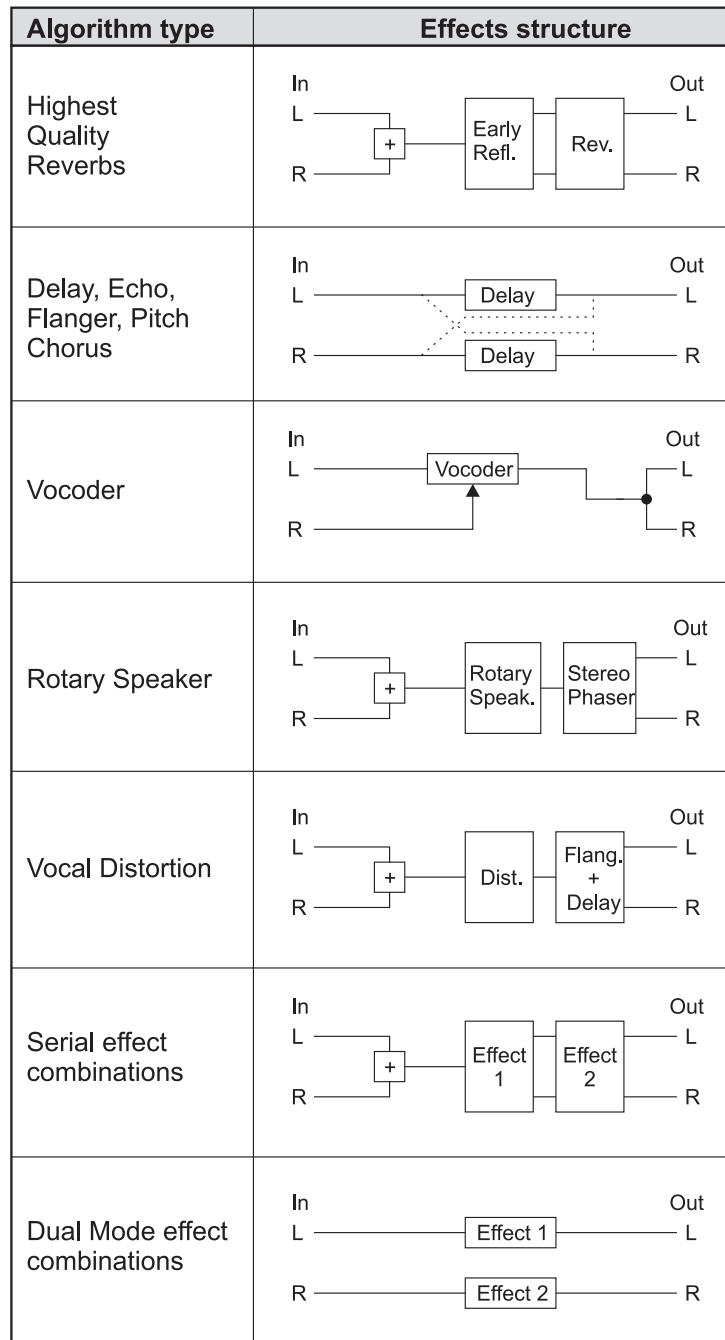



Fig. 2.1: Effects structure

### 2.2 Selecting presets

The VIRTUALIZER PRO stores 100 user-definable presets. After power-up, the unit automatically recalls the preset last used. To select another preset, use the jog wheel to enter the preset number of your choice. Turn the wheel clockwise to increment the preset number, or counterclockwise to decrement it.

 **Please note that the VIRTUALIZER PRO generally activates the newly selected presets only after about one second, which is indicated by a dot in the lower right corner of the display. After loading the data, the VIRTUALIZER PRO enables the preset and the dot disappears. This brief interruption avoids the direct activation of every preset, as you scroll through the preset list with the jog wheel. Otherwise incomplete "parameter remnants" of presets could reach the audio outputs of the VIRTUALIZER PRO, with possibly disastrous consequences, especially**



when using a high-power P.A. system. Thus, the VIRTUALIZER PRO makes sure that no "unwanted" programs are loaded unintentionally. Additionally, you can rotate the jog wheel at high speed and still have the time to specifically select the preset of your choice, instead of any of its "neighbours".

 The effect algorithms may have greatly varying output levels, reduce the sensitivity (input gain) of subsequent devices before changing programs.

## 2.3 Editing programs

Editing programs is easy on the VIRTUALIZER PRO. Basically, all essential parameters can be selected directly via the keypad and edited with the jog wheel. The list to the left of the display summarizes the effect algorithms that the VIRTUALIZER PRO can generate. Just press the EFFECT key to recall these basic algorithms and directly select them with the jog wheel. With the VARIATION key you can modify the selected effect in full detail, because each Variation does not only comprise one parameter but a set of several parameters. Thus, you can use the various Variations to tailor the sound of an effects program to suit your specific needs. The EDIT A and B keys enable you to edit essential single parameters of the selected effects program, while the EQ LO and EQ HI keys allow for adapting your own presets to match specific room acoustics or sound preferences. Use the ENGINE L and ENGINE R keys to edit the left or right audio channel settings. Of course, you can edit both channels at the same time in COUPLE mode. When entering COUPLE mode, the VIRTUALIZER PRO copies the parameter settings of the channel last activated to the other channel, so that both of them have an identical set of parameter values. Finally, you can also save the changes made to the preset.

## 2.4 Saving programs

Use the STORE key to save an edited preset. Basically, all parameter changes can be saved. Whenever you're editing a preset, the display starts flashing to indicate that the edits will be saved only when you confirm them by pressing the STORE key twice. Example:

▲ You recall a program for editing. Then you edit the preset as desired using the function keys and the jog wheel. During this process, the flashing STORE key reminds you that the preset settings have been changed but not saved yet. Press the STORE key once. The display reads the current preset number and starts flashing. To keep the original preset, use the jog wheel to select another preset that can be overwritten. Press the STORE key again to save the changes to the selected preset. If you wish to overwrite the original preset, simply press the STORE key twice (after editing) to save all changes you have made.

 Whenever you have edited a preset and pressed the STORE key twice, all previous settings in this preset are erased and overwritten with the new parameter values. However, if you wish to keep the original preset, use the jog wheel to select another preset *before* you press the STORE key a second time.

## 2.5 MIDI control

Use the MIDI key combination to select the MIDI parameters you wish to adjust. For this purpose, keep the IN/OUT and the STORE keys pressed for about two seconds. All parameters can be edited with the jog wheel and the IN/OUT key. The MIDI menu includes five pages which you can select by pressing the IN/OUT key several times.

On the first page you can select the MIDI channel. The display shows a small "c" (= channel). The jog wheel adjusts a channel from 1 through 16. To switch off the MIDI function, simply select the "0" value (displayed as "-").

On the second page you can select MIDI Omni mode, i.e. the unit transmits/receives on all 16 MIDI channels. The display reads "O" (=Omni). Use the jog wheel to activate ("1") or deactivate ("0") Omni mode.

The third page allows for configuring controller commands. On its right-hand side, the display shows a capital "C" (=Controller). The jog wheel selects one of the following four controller modes:

Display	Mode
0	No controller data are transmitted
1	Controller data are received but not transmitted
2	Controller data are transmitted but not received
3	Controller data are transmitted and received

Tab. 2.1: Controller settings

The fourth page gives you access to the program change setup. The display shows a capital "P" (=Program). Here, too, four modes can be selected with the jog wheel, as follows:

Display	Mode
0	Program changes are not transmitted
1	Program changes are received but not transmitted
2	Program changes are transmitted but not received
3	Program changes are transmitted and received

Tab. 2.2: Program change settings

The fifth page of the MIDI menu shows the "store enable" flag represented by a capital "S" in the display. The value "0" disables the reception of controller #28, and therefore protects the user presets from being modified via MIDI. Accordingly, the value "1" enables MIDI controller #28 so that you can modify or replace presets with a remote MIDI device or a sequencer. In this case the actual settings will be stored directly to the location that corresponds to the controller value.

 **Attention! Since the "store enable" mode allows you to access memory locations directly via MIDI, it is possible that stored presets will be replaced or altered if controller #28 messages are sent on the same MIDI channel. The purpose of this mode is to facilitate MIDI backup and restore operations without express confirmation at the VIRTUALIZER PRO. It is therefore recommended to disable (flag=0) this mode as soon as the intended data transfer has ended. This is done automatically when you switch off the VIRTUALIZER PRO.**

If you press the IN/OUT key again on the fifth page, the VIRTUALIZER PRO quits MIDI setup mode.

On the sixth and last page, you can access the "System Exclusive" functions. This is indicated by a "d" (for dump) in the display. To the left of this "d" a number is displayed:

- 0 means that no SYSEX data will be sent or accepted.
- 1 will enable the VIRTUALIZER PRO to receive data. When STORE is pressed the unit will wait for data, this is shown by flashing dots (LEDs) in the display. The MIDI key LED flashes signaling that SYSEX data is being received.
- 2 will enable the VIRTUALIZER PRO to send a "bulk dump". Start your sequencer and press STORE on the DSP1000P to start the transmission.

To load these settings again, select 1, press STORE and start your sequencer. If you press IN/OUT again, you will leave the MIDI setup. At all times you can press any other key to leave the MIDI setup directly.

 **During a bulk dump, all audio functions of the VIRTUALIZER PRO will be deactivated.**

The full-featured MIDI implementation of the VIRTUALIZER PRO allows for easily integrating of the VIRTUALIZER PRO into any MIDI system.

### ▲ MIDI IN

Any MIDI data sent to the VIRTUALIZER PRO (sequencer, MIDI footswitch, etc.) is received via the MIDI IN jack. For example, when you wish to use the VIRTUALIZER PRO as an effects devices for your guitar rack, you can connect the MIDI IN jack to a MIDI footswitch that allows for selecting program presets. If your rack includes another MIDI effects devices (e.g. a multi-effects processor), the data sent from the MIDI footswitch can be routed via the VIRTUALIZER PRO's MIDI THRU jack to your multi-effects processor.

### ▲ MIDI THRU

The MIDI THRU jack is used to loop through incoming MIDI data, i.e. any control data received at the MIDI IN of the VIRTUALIZER PRO can be transmitted via the MIDI THRU jack to other MIDI devices/instruments.

### ▲ MIDI OUT

The MIDI OUT jack allows for transmitting MIDI data that originate from the VIRTUALIZER PRO. We are currently developing a software editor which will allow for storing single items of the VIRTUALIZER PRO's internal data on an external medium, by using controller commands. Thus, it will be possible to archive VIRTUALIZER PRO settings and presets on a computer, sequencer or MIDI data recorder. Both MIDI Control Change and MIDI Program Change commands will be transmitted when you edit or recall filter settings (see 6.2). Detailed information on this future control are available from our BEHRINGER hotline (Germany: tel. (0)2154-920666), our international distributors and/or our Internet homepage <http://www.behringer.de>.



## 3. APPLICATIONS

The BEHRINGER VIRTUALIZER PRO is a highly flexible device that can be used for a wide variety of applications. Prior to a presentation of the VIRTUALIZER PRO's many uses, please note the following remarks on how to set signal levels correctly.

### 3.1 Level setting

Take care to set all levels properly on the VIRTUALIZER PRO! Low levels deteriorate the dynamics of the music signal, which results in a poor, weak and noisy sound. On the other hand, excess levels overdriving the converters in the VIRTUALIZER PRO should also be avoided. Digital distortion is (unlike its analog counterpart) very unpleasant to hear as it does not occur gradually but abruptly.

Use the input level meter of the VIRTUALIZER PRO to adjust the input signal to about -6 / -10 dB, so that the Clip LED flickers only rarely. Make sure that it never lights up all the time!

### 3.2 Using the VIRTUALIZER PRO in the aux bus

By using the VIRTUALIZER PRO in an aux bus of your mixing console you can feed the channel signals of one, several or even all console channels into the VIRTUALIZER PRO, i.e. for each channel you can use the aux busses to separately determine the reverb levels of, for instance, various drum sounds: while lots of reverb is applied to the snare drum, the effect intensity could be reduced in the channels assigned to the tom-toms. To use the VIRTUALIZER PRO in the aux bus, the unit must be wired as follows:

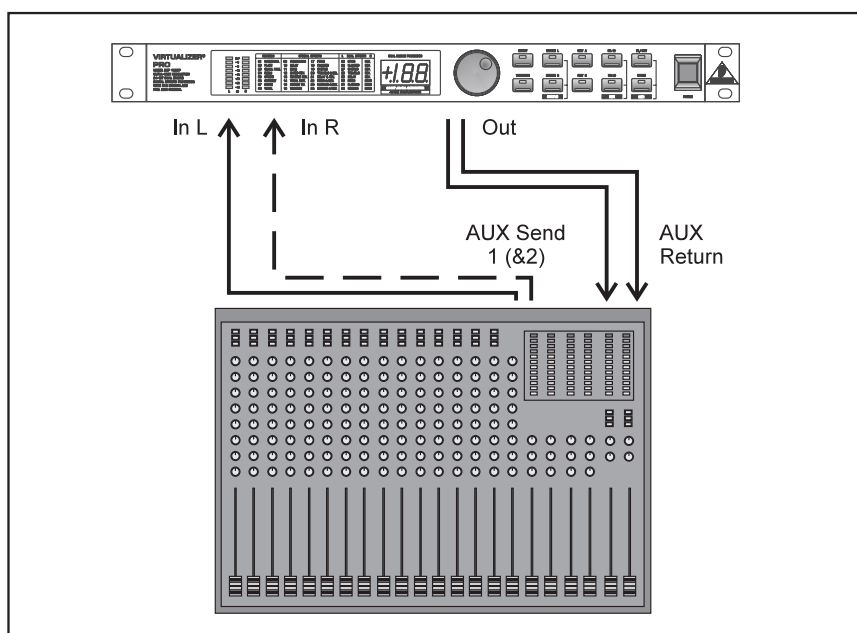

Fig. 3.1: Wiring aux busses

Connect the two Input phone jacks with the Aux Send outputs of the mixing console, and the Output jacks of the VIRTUALIZER PRO with the Aux Return inputs of the console. If you want to use the BEHRINGER VIRTUALIZER PRO in mono or dual mode, connect one audio channel (left or right) to one aux bus.

**☞ Turn down the volume on your amplifier to protect your equipment against damage. All devices you wish to interconnect should remain switched off until they are wired correctly.**

Let's suppose you wish to use the VIRTUALIZER PRO in a live application, interfaced with the F.O.H. mixer, to enhance the guitar sound with a subtle chorus effect.

▲ Connect the VIRTUALIZER PRO to the aux bus of your mixing console (fig. 3.1). Connect the units to the mains and adjust the operating level(s) if necessary. Switch on the VIRTUALIZER PRO and set the levels appropriately (see 3.1). Press the Mix combination to make sure that the unit is set to Mix External mode. Press the EFFECT key and use the jog wheel to select and thus activate the chorus effect (#19). Slowly turn up the aux bus level until the effect portion added to the guitar signal suits your needs. Subsequently, you can make all necessary fine-adjustments. We assume that you wish to edit the modulation frequency of the chorus effect: press the VARIATION key and set the modulation frequency with the jog wheel. To set the modulation delay, press the EDIT A key. The modulation depth of the chorus effect can be set by pressing the EDIT B key. Having edited all parameters as desired, you can save the changes to the original (or any other) preset.

### 3.3 Using the VIRTUALIZER PRO in the insert path

Basically, you can also insert the VIRTUALIZER PRO in a channel or subgroup of your mixing console. Use a dedicated insert cable. Inserting the VIRTUALIZER PRO in a single channel will be useful only if you wish to process a specific signal (e.g. vocals) with the VIRTUALIZER PRO, or if any other insert facilities of your mixing console are already in use.

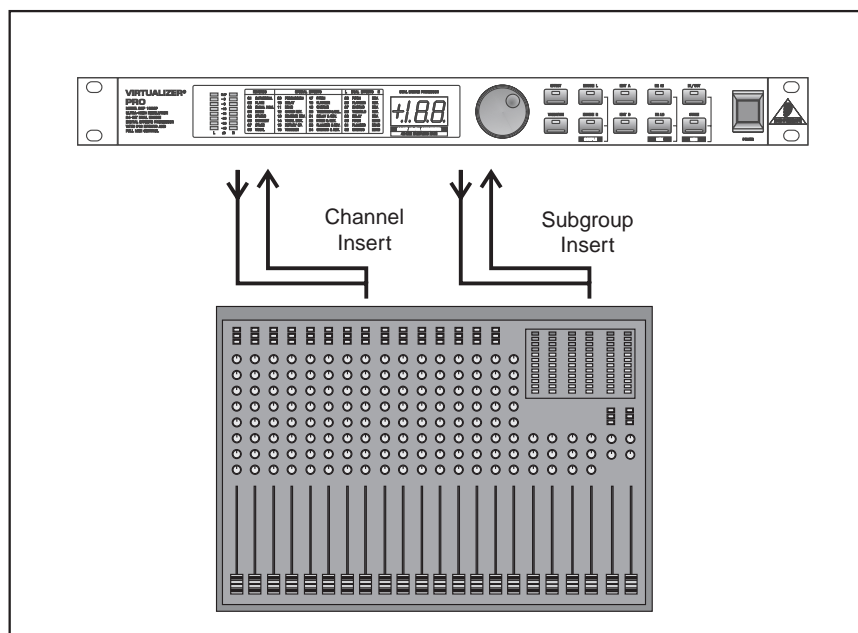

Fig. 3.2: Wiring the VIRTUALIZER PRO in the insert path

With certain special effects, for example the "Vocoder" effect, it is even more useful to insert the VIRTUALIZER PRO in a specific channel rather than connecting it to the aux bus. Proceed as follows: the signal from which you are going to generate the vocoder sound is routed to the left audio channel (e.g. keyboard sound), while the right audio channel can be used to control and modify this sound. Use a dedicated insert cable to connect the left audio channel with a channel insert on your mixing console (fig. 3.2). Connect the signal source to be processed with the vocoder effect (e.g. keyboard) to the normal channel input (XLR/jack). Connect the right audio channel of the VIRTUALIZER PRO with a controller (e.g. a microphone channel direct out). Talk into the microphone to control the keyboard sound with your voice, i.e. anything you sing or talk into the microphone is reproduced together with the keyboard sound.

### 3.4 Using the VIRTUALIZER PRO as an effects device for instruments

With its extensive MIDI implementation the VIRTUALIZER PRO can also be used, for instance, as a multi-effects device in a guitar rack. Of course, you can connect it up in both stereo and mono.

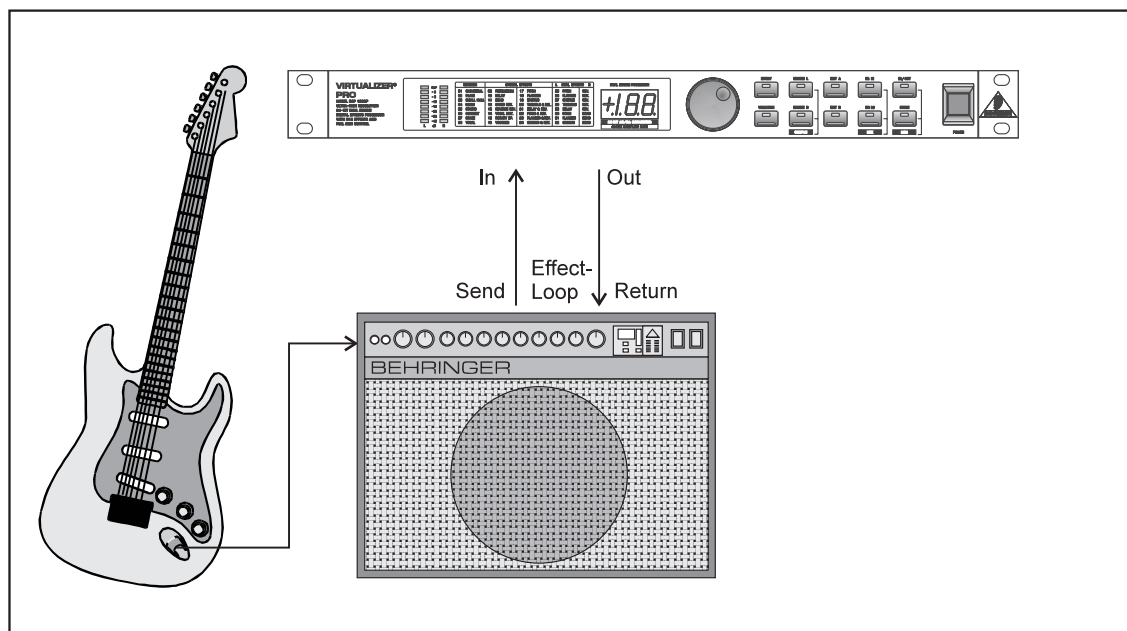

Fig. 3.3: Connecting the VIRTUALIZER PRO to a guitar amp (send/return-mono)

The following hints illustrate the VIRTUALIZER PRO's versatility if used with a guitar amp. Basically, the VIRTUALIZER PRO should be inserted between the preamp and the power stage. Almost all guitar amps have an insert or effect loop to send the preamp signal of the guitar amp to the audio inputs of the VIRTUALIZER PRO. The VIRTUALIZER PRO processes the preamp signal and sends it back via the guitar amp's return bus (power amp in), from where it is routed to the power stage. When you use a stereo rack system for amplification, you can wire the VIRTUALIZER PRO in stereo. Connect the preamp to the audio inputs of the VIRTUALIZER PRO, and the audio outputs (left/right) to one channel each of the power amp (left/right).

**Since most guitar amps only have a serial insert loop, you should make sure that the VIRTUALIZER PRO is set to Mix Internal mode. In this mode you can control the effect intensity applied to the guitar signal. However, if your amp features a parallel effect loop which allows for adding the effect-signal portion (similar to an aux path in a mixing console), we recommend that you use the VIRTUALIZER PRO's Mix External mode. In this case, the effect intensity present at the output of the VIRTUALIZER PRO is 100%, and you can use the effect loop to determine the amount of effect added to the guitar signal.**

Instrumentalists can benefit from a variety of advantages offered by the VIRTUALIZER PRO's MIDI implementation. For example, you can use a MIDI footswitch board to send program change commands via MIDI. Connect the MIDI OUT jack of your MIDI board to the MIDI IN jack on the VIRTUALIZER PRO. If the VIRTUALIZER PRO fails to respond to the program change commands sent from the MIDI board, check the MIDI channel settings. Consult the user's manual of your MIDI board to find out on which channels program change commands are transmitted (usually in Omni mode). Set the MIDI channels appropriately in MIDI mode (see 2.5) and enable the VIRTUALIZER PRO to receive program change commands.

If your MIDI board features a controller or allows you to connect controller pedals, you can even change parameter settings via MIDI while playing. For instance, you can freely change the effect intensity from 0-100% while playing (Contr. 27, Value 0 - 100). Set the controller for Mix-Internal mode (Contr. 30, Value 0) so that it can be used to increase the effect intensity. In this way, guitar solos can be enhanced with chorus and delay effects, while the effect intensity is gradually reduced when playing rhythm. You can even control the function of the In/Out switch to bypass the VIRTUALIZER PRO when an unprocessed signal is needed. Basically, all MIDI devices that are capable of transmitting MIDI controller commands, e.g. keyboards/sequencers, will allow for using these features.

The VIRTUALIZER PRO may also be inserted between the outputs of a keyboard and the inputs of a mixing console. If required, adjust the levels with the Operating Level switch (see 3.1).

### 3.5 Using the VIRTUALIZER PRO in a MIDI system

With its built-in MIDI interface the VIRTUALIZER PRO can be integrated into any MIDI system. It transmits and receives both program change and controller change information to perform program changes via MIDI from a sequencer or any other MIDI device. Wire and set up the VIRTUALIZER PRO as shown below:

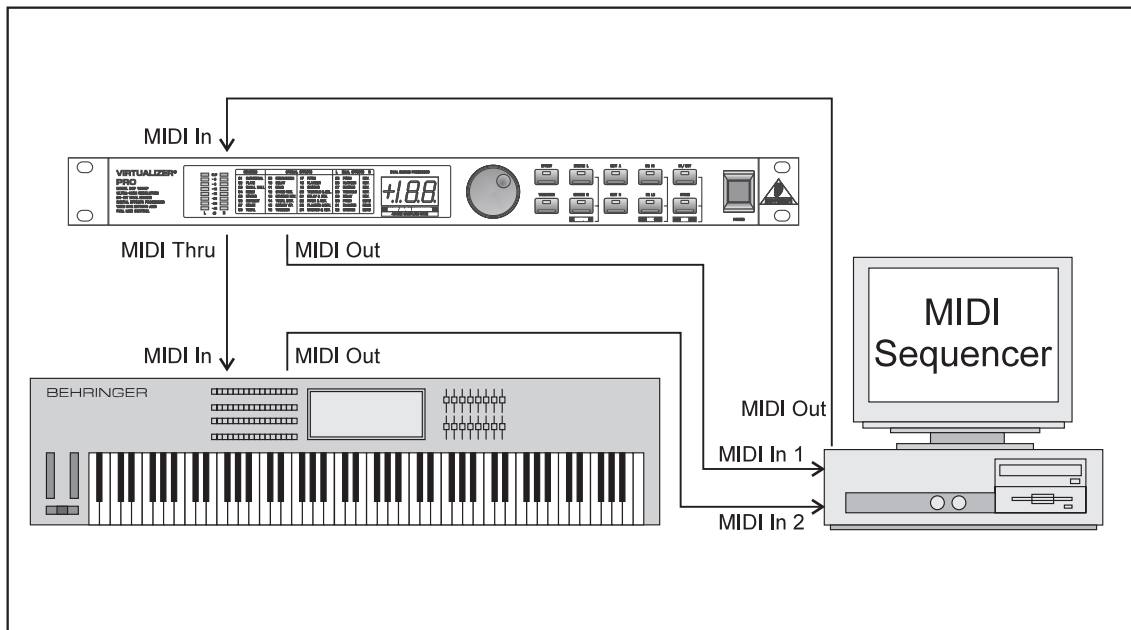

Fig. 3.4: Connecting the VIRTUALIZER PRO via MIDI to a sequencer/computer and a keyboard (optional)

### 3.6 Saving data via MIDI

The VIRTUALIZER PRO's MIDI implementation also allows for archiving one or several presets on an external storage medium. Proceed as follows:

Connect the MIDI OUT jack of the VIRTUALIZER PRO to the MIDI IN jack of a MIDI data recorder (e.g. sequencer). Press the STORE and In/Out keys simultaneously to enter MIDI mode. Set program change mode to 0 and controller change mode to 3. Now quit MIDI mode by pressing the STORE key. Use the jog wheel to select the preset whose data you wish to save. When the preset is activated its parameters are transmitted as controller data and can be recorded on a sequencer or similar device. Repeat this routine until all presets of your choice have been sent to the external data recorder.

To load archived data back into the VIRTUALIZER PRO, you must enable controller reception in MIDI mode (see 2.5). Then, start the sequencer to automatically transmit each preset data set back to the VIRTUALIZER PRO. Press the STORE key, select a program location to store the data and then press the STORE key again. If you want to automate MIDI store functions you must enable the store mode, to switch on the reception of controller #28. This allows you to directly store any modifications of the actual preset on the preset number that is transmitted with the controller. You can also restore a complete preset that has previously been recorded with a MIDI sequencer on the same location it had before.

## 4. TECHNICAL BACKGROUND

### 4.1 Digital Audio Processing

In order to convert an analog signal – e.g. music – into a series of digital words, a so-called “Analog to Digital Converter” or ADC is used. The converter works by viewing the incoming signal 44,100 times per second, giving a rate of 44.1 kHz, and in each case measuring the signal amplitude, and giving it a numerical value. This form of measuring the signal regularly over a period of time is known as “sampling”, the conversion of the

amplitude into a numerical value, quantizing. The two actions together are referred to as digitizing.

In order to carry out the opposite – the conversion of a digitized signal into its original analog form – a “Digital to Analog Converter” or DAC is used. In both cases the frequency at which the device operates is called the sampling rate. The sampling rate determines the effective audio frequency range. The sampling rate must always be more than twice the value of the highest frequency to be reproduced. Therefore, the well known CD sampling rate of 44.1 kHz is slightly higher than twice as high as the highest audible frequency of 20 kHz. The accuracy at which quantization takes place is primarily dependent on the quality of the ADCs and DACs being used.

The resolution, or size of digital word used (expressed in bits), determines the theoretical Signal/Noise ratio (S/N ratio) the audio system is capable of providing. The number of bits may be compared to the number of decimal places used in a calculation – the greater the number of places, the more accurate the end result. Theoretically, each extra bit of resolution should result in the S/N ratio increasing by 6 dB. Unfortunately, there are a considerable number of other factors to be taken into account, which hinder the achievement of these theoretical values.

If you picture an analogue signal as a sinusoidal curve, then the sampling procedure may be thought of as a grid superimposed on the curve. The higher the sampling rate (and the higher the number of bits), the finer the grid. The analog signal traces a continuous curve, which very seldom coincides with the cross points of the grid. A signal level at the sampling points will still be assigned a digital value, usually the one closest to the exact representation. This limit to the resolution of the grid gives rise to errors, and these errors are the cause of quantizing noise. Unfortunately, quantizing noise has the characteristic of being much more noticeable and unpleasant to the ear than “natural” analog noise.

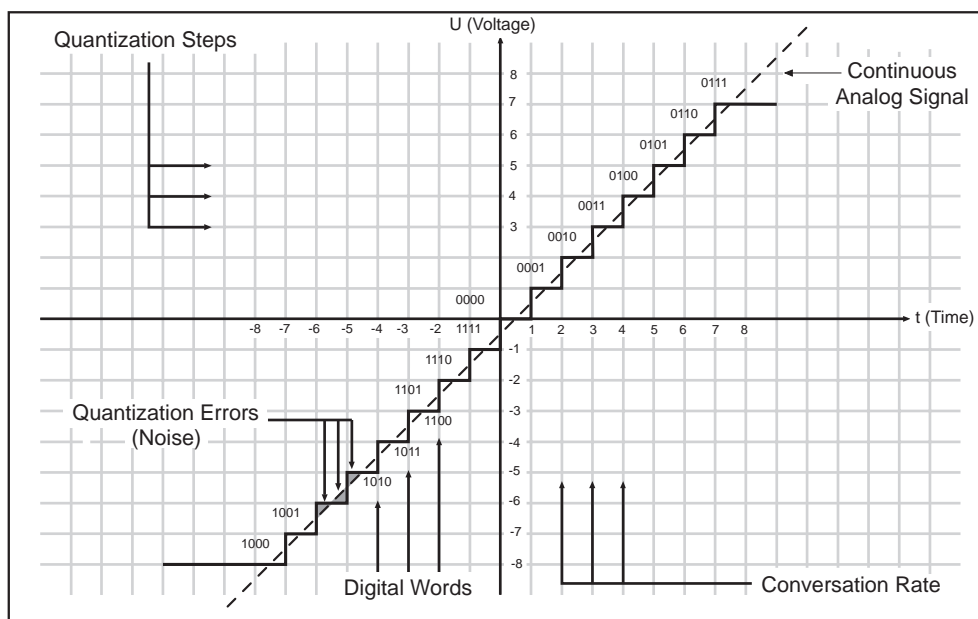

Fig. 4.1: Transfer diagram for an ideal linear ADC (2's complement representation)

In a digital signal processor, such as the DSPs in the VIRTUALIZER PRO, the data will be modified in a number of ways, in other words, various calculations, or processes, will be done in order to achieve the desired effect on the signal. This gives rise to further errors, as these calculations are approximations, due to their being rounded off to a defined number of decimal places. This causes further noise. To minimize these rounding off errors, the calculations must be carried out with a higher resolution than that of the digital audio data being processed (as a comparison, an electronic calculator may operate internally with a greater number of decimal places than can be shown on its display). The DSPs in the VIRTUALIZER PRO operate with a 24 bit resolution. This is accurate enough to reduce quantizing noise to levels which are usually below the audible threshold. However, when using extreme equalizer settings, some quantizing side effects may be detected.

Digital sampling has one further, very disturbing effect: it is very sensitive to signal overload. For example, if an analog signal starts to overload, it results in the amplitude of the signal reaching a maximum level, and the peaks of the wave will start to get compressed, or flattened. The greater the proportion of the wave being flattened, the more harmonics, audible as distortion, will be heard. This is a gradual process, the level of



distortion as a percentage of the total signal rising with the increase of the input signal level.

Digital distortion is quite different, as illustrated by the following example. If we take the situation where a 4 bit word has the positive maximum value of 0111, and add to it the smallest possible value of 0001 (in other words, the smallest increase in amplitude possible), the addition of the two results in 1000 – the value of the “negative” maximum. The value is turned on its head, going instantly from positive max to negative max, resulting in the very noticeable onset of extreme signal distortion.

## 4.2 Reverberation and reflection

Prior to simulating the physical phenomena of reverberation and reflection, it is necessary to analyze how reverb is generated, and how it is perceived by human hearing.

In a concert hall the sound the listener hears comprises both the source signals (e.g. acoustical instruments, P.A. system) and thousands of reflections of these “primary signals”, which bounce off floor, ceiling and walls to reach the ear after a short delay. These reflections represent thousands of echoes of the direct signal, which are not perceived any longer as single echoes, but due to their sheer number – as reverberation. Basically, the reflected signal portions reach the ear later than the source signal, and the very fact that they do not arrive from the same direction as the direct signal (see fig. 4.2), makes it possible to hear “spatial information”, i.e. to perceive the direct signal as if it is “embedded” in the room acoustics.

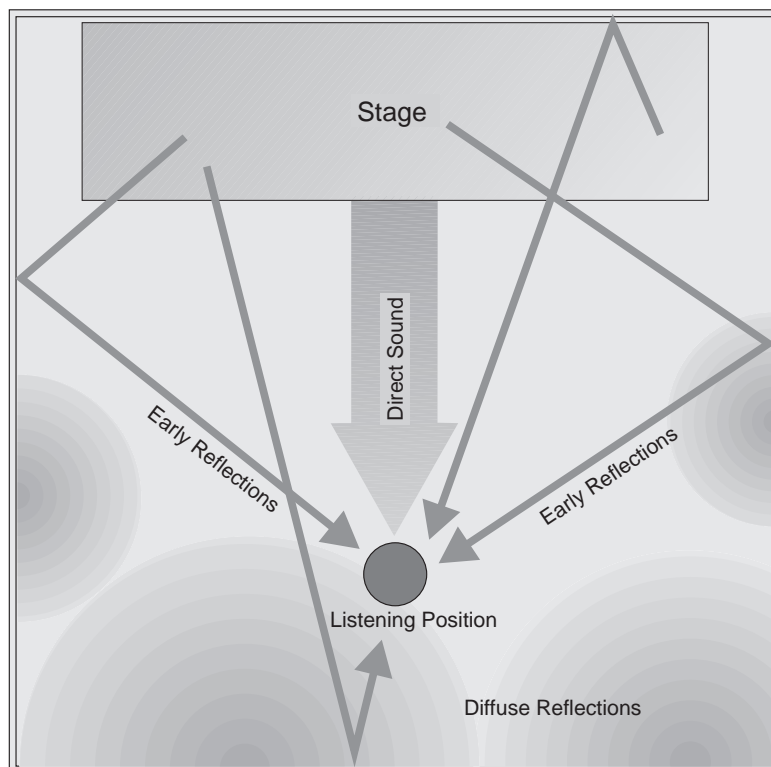

Fig. 4.2: Direct and reflected sounds reaching the listener's ear

Spatial information is an important means of orientation, because human hearing is also used to determine the position of a sound source. In certain situations, this capability can be very useful or even of vital importance. The fact that we can actually “hear” the size of a room shows how strongly developed the human sense of hearing actually is. Based on the reflectivity of a room, we can also distinguish (though we often don't know how) the materials it consists of. In large rooms with high tiled walls reverberation is generally very dense and needs some time to decay, while a small room with many objects in it (furniture, carpets, etc.) features very short reverberation often not even perceived as such. Nevertheless, this extremely short reverb does exist, which is the reason why many designers of reverb devices (such as our VIRTUALIZER PRO) implement several basic reverb types and give them specific room names. It is quite natural, for example, that a reverb preset called “Cathedral” produces a long and highly dense reverb, while a “Room” program usually represents the



acoustics of a room that is much smaller in size.

In addition to the capability of human hearing to determine the direction from where a sound phenomenon arrives, we can also hear modulations of acoustic events. Of importance in this context is the frequency of the modulated signals. Frequency modulations below 100 Hz are virtually inaudible. However frequency modulations can clearly be heard when occurring in the midrange frequency band, due to the "sensitivity" of human hearing. The ear immediately detects changes in midrange frequencies, while its sensitivity to frequency modulation in the extreme low end of the frequency spectrum is reduced. Frequency modulation can also be used to produce "wanted" effects. The popular chorus effect, for instance, is basically the sum of a variety of frequency modulations. The original signal is slightly delayed in the chorus algorithm, then added again and modulated by means of an oscillator. Subsequently, modulating frequencies (of different pitch) are applied to the original signal, which produces the well-known "floating" chorus sound. Basically, frequency modulation is the starting point for all kinds of chorus-type effects: by simply adding the delayed signal, without modulating the original, you can produce a delay effect. Since chorus effects use very short delay times, the resulting delay effect is not perceived as such. However, when you increase the delay time, there is a clear gap between original and effect signals, and delay becomes audible. A highly intensive effect can be achieved by combining reverb/delay programs with modulation effects. For this reason, the BEHRINGER VIRTUALIZER PRO also features multi-effects programs combining reverb or delay with, for example, a chorus effect.

In addition to the multi-effects programs and special-purpose effects, most of the VIRTUALIZER PRO's effect programs offer "pure" reverb programs, because "common" reverb is still the most important effect for mix-down or live applications. Therefore, we at BEHRINGER want to provide you with a variety of reverb programs, so that you have appropriate presets available for each specific application.

Before you can simulate any reverb phenomena, you need to identify the major parameters of natural reverberation and use them to create a mathematical algorithm. The BEHRINGER VIRTUALIZER PRO benefits from the newly developed virtual acoustics algorithm. Unlike many other conventional reverb algorithms, the virtual acoustics algorithm reproduces the essential parameters of typical reverb rooms with considerably more detail and realism.

#### 4.2.1 Reverberation chambers

Reverberation chambers deliver the most natural form of reverb. In general, every room has its specific acoustic properties which are not only dependent on its size but also on its shape (architecture) and the materials used to construct it. For this reason, experts in architectural acoustics design rooms (concert halls, recording studios, etc.) to produce a specific sound and reverb ambience.

Even today almost all recordings of classical music and a major part of jazz recordings are performed in a dedicated recording room. Important professional studios sometimes have special reverberation chambers tuned to produce a specific ambience. They can be built entirely from wood, ceramics or natural stones to generate a specific sound in a very natural way. Some high-end studios even have facilities to adjust the walls and ceilings so as to generate distinct reverb ambiences or sound images. However, as the cost of such rooms are extremely high, newly built studios simply cannot afford a dedicated reverberation chamber. Understandably, no reverb unit can produce reverberation that is more natural in character than the ambience generated by a natural reverberation chamber. On the other hand, reverberation chambers do suffer from three decisive drawbacks:

- ▲ It is not possible to modify the reverb sound (except for rooms with adjustable walls and ceilings), so when using natural reverb you cannot change its decay time or intensity.
- ▲ Natural reverberation chambers cannot be used to generate special surreal reverb phenomena, e.g. extremely long decay times or reverse reverb.
- ▲ Reverberation chambers are not portable! If you wish to use one particular reverb ambience, you will have to record in the specific room that produces it. In a way, each reverberation chamber is unique.

#### 4.2.2 Spring and plate reverb

Due to the disadvantages of natural reverb chambers (see section 4.2), two new methods of generating reverb were invented and used in the 50's and 60's. For the first time ever, plate or spring reverb devices allowed for the artificial production of reverberation. A reverb plate consists of a thin steel plate or sturdy metal sheet coated with a gold alloy, which is set in motion by a generator radiating the signal to be processed (reverberated). At another point somewhere on the plate, the signal is picked up by a transducer and then added to the original signal. "Plate" reverb is quite natural in character because the vibrations of the plate are similar to air vibrations

in a (reverberation) room, i.e. they are spread in all directions, are reflected when they reach the plate edges, and you can basically distinguish between early and later reflections. The result is an almost natural reverb ambience, however, whose decay time cannot be modified.

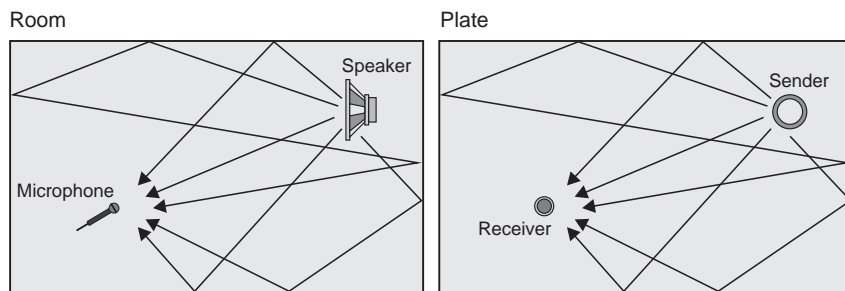

Fig. 4.3: Room reflections and reverb plate reflections

Spring reverb devices use a similar principle, but their reverb sound is of inferior quality compared to a properly adjusted reverb plate. In particular, dynamic signals such as drums have a highly compressed and “flat” sound when they are reproduced with a spring reverb. Still, spring reverbs can be found even today in guitar amplifiers. Due to the speakers used in such amps, there are no extremely high frequencies to be processed, so lower reverb quality (in particular, in view of the cost) can be an acceptable alternative for guitarists. Yet, spring reverb designs suffer from a few drawbacks limiting their professional use:

- ▲ The parameters of spring reverb devices cannot be modified or edited. To allow for different reverb decay times, you would need to alter the physical properties of the springs.
- ▲ The “clattering” sound of spring reverbs is a much-dreaded effect, in particular, on stage. Shock can set the reverb spring in motion so that it hits against its enclosure. The resulting noise resembles that of thunder.
- ▲ Spring reverb is of poor quality, especially with percussive signals, which is the reason why the use of such devices in recording studios is highly limited.

#### 4.2.3 Digital reverb

With the development of digital reverb devices, spring reverbs and reverb plates have almost completely vanished from the studio, because digital devices feature a wealth of advantages:

- ▲ Excellent reverb quality.
- ▲ Mass production allows for reducing the prices of digital reverb devices.
- ▲ Many parameters can be modified and stored.
- ▲ With their compact design digital devices are easily portable.
- ▲ Digital devices need almost no maintenance and are virtually unsusceptible to interference.

Basically, digital reverberation tries to provide a virtual simulation of real (in specific situations even surreal) reverb phenomena by means of algorithms computed by an effects processor. The quality of this simulation largely depends on the software (algorithms), the performance features of the processor used and the quality of the AD/DA converters. Since natural reverb comprises thousands of single echoes, a fast processor must be used to perform the complex calculations needed. To make the reverb programs sound natural, appropriate software must be used to be able to control the most essential parameters of a reverb phenomenon. For example, signal diffraction, reflections from different kinds of material, phase shift and room resonances must be calculated. Consequently, digital devices allow editing of many more parameters than reverb plates or spring reverbs do. In almost all digital devices, (at least) the following parameters can be modified:

- ▲ Pre-delay time: this parameter determines the time between the occurrence of original signal and first reflections.
- ▲ Decay time: determines the duration of the reverb (in seconds).
- ▲ High-damp: a function that allows for equalizing the reverberated sound in the higher frequency range. To simulate the sound of a heavily damped room, for instance, the high-frequency portions in the reverb signal must be reduced.

## 5. INSTALLATION

Your BEHRINGER VIRTUALIZER PRO was carefully packed in the factory and the packaging was designed to protect the unit from rough handling. Nevertheless, we recommend that you carefully examine the packaging and its contents for any signs of physical damage, which may have occurred in transit.

 **If the unit is damaged, please do not return it to us, but notify your dealer and the shipping company immediately, otherwise claims for damage or replacement may not be granted. Shipping claims must be made by the consignee.**

E

### 5.1 Rack mounting

The BEHRINGER VIRTUALIZER PRO fits into one standard 19" rack unit of space (1 3/4"). Please allow at least an additional 4" depth for the connectors on the back panel. Be sure that there is enough air space around the unit for cooling and please do not place the VIRTUALIZER PRO on high temperature devices such as power amplifiers etc. to avoid overheating.

### 5.2 Mains connection

The mains connection of the VIRTUALIZER PRO is made by using a mains cable and a standard IEC receptacle. It meets all of the international safety certification requirements.

 **Please make sure that all units have a proper ground connection. For your own safety, do not remove the ground connection within the units or at the supply, or fail to make this connection at all.**

Before you switch on the unit, check that it is configured to match your AC mains voltage requirements. If it does not comply, then it is necessary to switch the operating voltage to the correct supply requirements BEFORE turning on the unit, otherwise the unit could be severely damaged. You will find this combined fuse holder/voltage selector at the back, adjacent to the IEC receptacle. **IMPORTANT: This does not apply for general export models which are built for one operating voltage only.**

The AC voltage selection is defined by the position of the fuse holder. If you intend to change the operating voltage, remove the fuse holder and twist it by 180 degrees before you reinsert it. Matching the two markers monitors the selected voltage.

 **If the unit is switched to an other operating voltage, the fuse rating must be changed. See the technical specifications in the appendix**

A safety fuse protects the unit from serious defects. If the fuse blows, this is a warning sign and always indicates that the circuit is overloaded. The fault must always be repaired before the fuse is replaced. If the safety fuse is faulty and needs replacing after the unit is repaired, please make sure that you replace it only with the identical type and rating. NEVER use fuses of different ratings or cover faulty fuses with aluminium foil. This can cause fire and electric shocks and will endanger your life and the lives of others.

### 5.3 Audio connections

As standard, the BEHRINGER VIRTUALIZER PRO is installed with electronically servo-balanced inputs and outputs. The new circuit design features automatic hum and noise reduction for balanced signals and thus allows for trouble-free operation, even at high operating levels. Externally induced mains hum etc. will be effectively suppressed. The automatic servo-function recognizes the presence of unbalanced connectors and adjusts the nominal level internally to avoid level differences between the input and output signals (correction 6 dB).

 **Please ensure that only qualified persons install and operate the VIRTUALIZER PRO. During installation and operation the user must have sufficient electrical contact to earth. Electrostatic charges might affect the operation of the VIRTUALIZER PRO!**

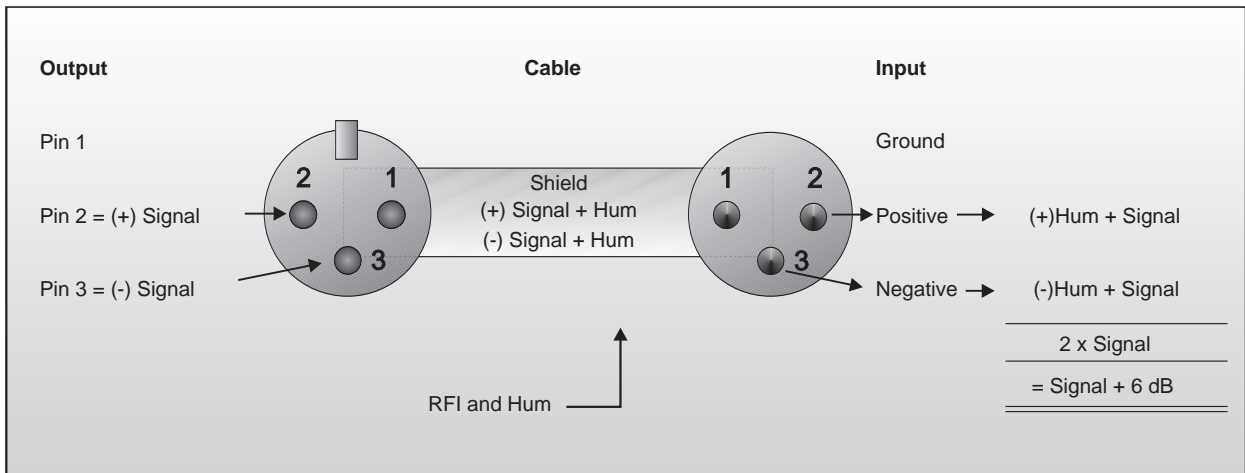

Fig. 5.1: Compensation of interference with balanced connections

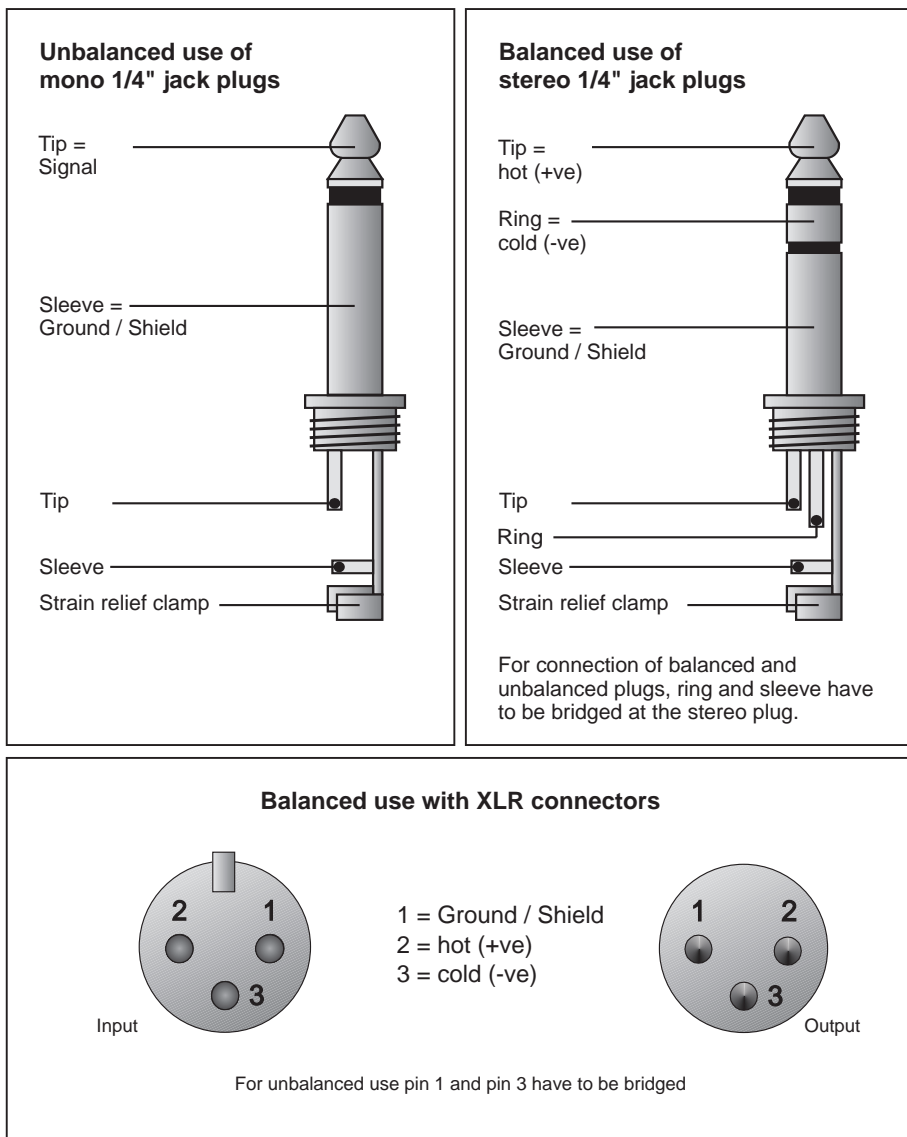

Fig. 5.2: Different plug types



## 5.4 MIDI connections

The MIDI standard was developed in the early 1980s to allow electronic musical instruments from different manufacturers to communicate with each other. The use of MIDI has developed over the intervening years to the stage where it is now common to find complete recording studios operating entirely on a MIDI basis. The centerpiece in such a studio is usually a computer running a sequencer software which not only controls various keyboards, samplers and sound modules, but can also run the programming of outboard effect devices, typically digital reverberation and delay units. The VIRTUALIZER PRO may be controlled in real time in this studio environment.

### **MIDI for Musical Instruments Digital Interface.**

The MIDI connectors found on the rear panel are of the universally used 5 pin DIN type. You require suitable MIDI cables to connect the VIRTUALIZER PRO to other MIDI devices. Normally complete cables will be purchased for this use, you can of course make your own, using a high quality cable with two cores and shielding (like microphone cable), with as connectors two good 180 degree DIN plugs. Pin 2 (center) is connected to the cable's shield, pins 4 and 5 (left and right next to 2) carry the two cores, pins 1 and 3 are not used. MIDI cables should have a maximum length not exceeding 45 feet.

## 5.5 Operating Level switch

To adapt the VIRTUALIZER PRO to the used operating level, the unit can be switched between homerecording level (-10 dBV) and professional level (+4 dBu). Use the LED bars on the frontpanel to determine the optimal setting. The Level indicators should read somewhere around -6 / -10 dB, while the clip LED should not light up at all.

## 6. APPENDIX

### 6.1 Parameter overview

Nr.	EFFECT	VARIATION		EDIT A		EDIT B	
		ENGINE L	ENGINE R	ENGINE L	ENGINE R		
1	CATHEDRAL		Reverb Time	Diffusion	Early Reflections	High Multiply	
2	PLATE		Reverb Time	Pre Delay	Stereo Width	High Multiply	
3	SMALL HALL		Reverb Time	Diffusion	Early Reflections	Stereo Width	
4	ROOM		Reverb Time	Pre Delay	Wall Damp		
5	STUDIO		Reverb Time	Pre Delay	Early Reflections	Wall Damp	
6	CONCERT		Reverb Time	Pre Delay	Early Reflections	Diffusion	
7	STAGE		Reverb Time	Diffusion	Liveliness	Stereo Width	
8	VOCAL		Reverb Time	Pre Delay	Early Reflections	High Multiply	
9	PERCUSSION		Reverb Time	Diffusion	High Frequency Decay		
10	DELAY		Del. Coarse	Delay Time	Feedback	Feedback	
11	ECHO		Del. Coarse	Delay Time	Feedback	Feedback	
12	GATED REVERB		Gate Time	Density	Gate Threshold		
13	REVERSE REVERB		Gate Time	Pre Delay	Gate Threshold		
14	VOCAL DISTORTION		Distortion Type	Delay Time (x 10 ms)	Delay Mix		
15	ROTARY SPEAKER		Rotary Type	Horn Speed	Rotor Speed		
16	VOCODER		Vocoder Type	Vocoder Distortion	Vocoder Sens		
17	PITCH			Cent	Semi Tone	Semi Tone	
18	FLANGER		Mod. Frequency	Mod. Depth	Mod. Feedback	Mod. Feedback	
19	CHORUS		Mod. Frequency	Mod. Delay	Mod. Depth	Mod. Depth	
20	TREMOLO & DELAY		Mod. Frequency	Mod. Depth	Panning	Delay Feedback	
21	DELAY & REVERB		Del. Mix	Del. Time (x 10 ms)	Reverb Time	Reverb Mix	
22	PITCH & REVERB			Cent	Reverb Time	Reverb Mix	
23	FLANGER & REVERB		Mod. Frequency	Mod. Depth	Reverb Time	Reverb Mix	
24	CHORUS & REVERB		Mod. Frequency	Mod. Delay	Reverb Time	Reverb Mix	
25	PITCH / REVERB			Cent	Reverb Time	Reverb Mix	
26	FLANGER / REVERB		Mod. Frequency	Mod. Depth	Semi Tone	High Multiply	
27	CHORUS / REVERB		Mod. Frequency	Mod. Delay	Mod. Feedback	High Multiply	
28	TREMOLO / REVERB		Mod. Frequency	Mod. Depth	Mod. Depth	High Multiply	
29	DELAY / REVERB			Del. Time (x 10 ms)	Delay Feedback	High Multiply	
30	PITCH / ECHO			Cent	Delay Feedback	High Multiply	
31	FLANGER / ECHO		Mod. Frequency	Mod. Depth	Semi Tone	Delay Feedback	
32	CHORUS / ECHO		Mod. Frequency	Mod. Delay	Mod. Feedback	Delay Feedback	

Tab. 6.1: Parameter overview of the different effect types

## 6.2 Delay values / increments for presets 10 and 11

Variation Type	Edit A				Step Size (L & R)
	Delay (L)		Delay (R)		
	From (ms)	Until (ms)	From (ms)	Until (ms)	
1	0	315	0	315	5
2	320	635	320	635	5
3	640	955	640	955	5
4	960	1275	960	1275	5
5	0	315	320	635	5
6	0	315	640	955	5
7	0	315	960	1275	5
8	320	635	640	955	5
9	320	635	960	1275	5
10	640	955	960	1275	5
11	0	630	1280	1910	10
12	0	630	1920	2550	10
13	0	630	2560	3190	10
14	0	630	3200	3830	10
15	640	1270	1280	1910	10
16	640	1270	1920	2550	10
17	640	1270	2560	3190	10
18	640	1270	3200	3830	10
19	1280	1910	1920	2550	10
20	1280	1910	2560	3190	10
21	1280	1910	3200	3830	10
22	1280	1910	3840	4470	10
23	1920	2550	2560	3190	10
24	1920	2550	3200	3830	10
25	1920	2550	3840	4470	10
26	1920	2550	4480	5110	10
27	2560	3190	3200	3830	10
28	2560	3190	3840	4470	10
29	2560	3190	4480	5110	10
30	3200	3830	3840	4470	10
31	3200	3830	4480	5110	10
32	3840	4470	4480	5110	10

Fig. 6.2: Increment table for presets 10 and 11



### 6.3 MIDI-implementation

MIDI Implementation Chart				
Funktion		Übertragen	Erkannt	Bemerkung
Basic Channel	Default	OFF, 1 - 16	OFF, 1 - 16	gespeichert
	Changed	OFF, 1 - 16	OFF, 1 - 16	
Mode	Default Messages	1,2,3,4	1,2,3,4	
	Altered	X	X	
Note Number		X	X	
	True Voice	X	X	
Velocity	Note ON	X	X	
	Note OFF	X	X	
After Touch	Key's	X	X	
	Ch's	X	X	
Pitch Bender		X	X	
Control		O 20 - 30	O 20 - 30	s. Tabelle 8.3
Progr. Change		O (0-99)	O (0-99)	
	True #	1-100	1-100	
System Exclusive		X	X	
System Common	Song Pos	X	X	
	Song Sel	X	X	
	Tune	X	X	
System Real Time	Clock	X	X	
	Commands	X	X	
Aux Messages	Local ON/OFF	X	X	
	All notes OFF	X	X	
	Active Sense	X	X	
	Reset	X	X	
Notes				

O = JA, X = NEIN

- Mode 1: OMNI ON, POLY
- Mode 2: OMNI ON, MONO
- Mode 3: OMNI OFF, POLY
- Mode 4: OMNI OFF, MONO

Tab. 6.3: MIDI implementation chart

Parameter Name	Display Range	Midi-Controller	Controller Range	LEDs			
				Couple	Left	Right	IN on IN off
Effect	1..32	20	0..31				
Variation	1..32	21	0..31				
Engine		22	0,1,2	0	1	2	
Edit A	0..63 / -50..50	23	0..63 / 0..100 (1)				
Edit B	0..63 / -12..12	24	0..63 / 0..24 (2)				
EQ LO	-16..16	25	0..32				
EQ HI	-16..16	26	0..32				
Mix	0..100	27	0..100				
Store	1..100	28	0..99				
IN/OUT		29	0,1				1 0
Mix Intern/Extern	0..100 / --	30	0,1				

(1) when the effect has a cent-function (for instance pitch)

(2) when the effect has a semitone-function (for instance pitch)

Tab. 6.4: Controller functions with MIDI



## 6.4 Default settings

No.	Effect	Variation	Engine Left		Engine Right	
			Edit A	Edit B	Edit A	Edit B
1	Cathedral	11	63	53	-	50
2	Plate	14	9	50	-	20
3	Small Hall	4	50	39	-	63
4	Room	30	0	29	-	-
5	Studio	9	9	49	-	31
6	Concert	23	20	51	-	63
7	Stage	20	55	60	-	63
8	Vocal	14	28	46	-	52
9	Percussion	8	63	27	-	-
10	Delay	1	24	30	24	30
11	Echo	1	37	30	37	30
12	Gated Reverb	5	50	21	-	-
13	Reverse Reverb	8	63	21	-	-
14	Vocal Distortion	12	15	16	-	-
15	Rotary Speaker	14	18	14	-	-
16	Vocoder	4	10	56	-	-
17	Pitch	-	+0	+0	+0	+0
18	Flanger	1	6	56	6	56
19	Chorus	1	32	63	32	63
20	Tremolo & Delay	19	63	63	0	0
21	Delay & Reverb	21	63	9	57	56
22	Pitch & Reverb	-	+6	+0	50	52
23	Flanger & Reverb	4	63	63	32	38
24	Chorus & Reverb	6	20	30	63	43
25	Pitch / Reverb	-	+0	+0	21	40
26	Flanger / Reverb	4	63	63	21	40
27	Chorus / Reverb	1	27	60	21	40
28	Tremolo / Reverb	17	0	0	21	40
29	Delay / Reverb	-	55	20	21	40
30	Pitch / Echo	-	+0	+0	40	23
31	Flanger / Echo	1	8	60	63	16
32	Chorus / Echo	1	34	40	31	23

Tab. 6.5: Default settings

## 6.5 Specifications

### Analog Inputs

Connectors	XLR and 1/4" jack
Type	RF filtered, servo balanced input
Impedance	60 kOhms balanced, 30 kOhms unbalanced
Nominal Operating Level	-10dBV to +4dBu
Max. Input Level	+16 dBu at +4 dB nominal level, +2 dBV at -10 dBV nominal level

### Analog Outputs

Connectors	XLR and 1/4" jack
Type	Electronically servo-balanced output stage
Impedance	60 Ohms balanced, 30 Ohms unbalanced
Max. Output Level	+16 dBu at +4 dB nominal level, +2 dBV at -10 dBV nominal level

### System specifications

Bandwidth	20 Hz to 20 kHz, +0/-3 dB
Noise	>-94 dBu, unweighted, 20 Hz to 20 kHz
THD	0.0075 % typ. @ +4 dBu, 1 kHz, Gain 1
Crosstalk	< -76 dBu

### MIDI Interface

Type	5-Pin-DIN-Socket IN / OUT / THRU
------	----------------------------------

### Digital Processing

Converters	20-bit Sigma-Delta, 64/128-times Oversampling
Sampling Rate	46,875 kHz

### Display

Type	2 ½-digit numeric LED-Display
------	-------------------------------

### Power Supply

Mains Voltages	USA/Canada	~ 120 V AC, 60 Hz
	U.K./Australia	~ 240 V AC, 50 Hz
	Europe	~ 230 V AC, 50 Hz
	General Export Model	~ 100-120 V AC, ~ 200-240 V AC, 50-60 Hz
Fuse	100-120 V AC:	<b>125 mA (slow-blow)</b>
	200-240 V AC:	<b>63 mA (slow-blow)</b>
Power Consumption		10 Watts
Mains Connection		Standard IEC receptacle

### Physical

Dimensions (H * W * D)	1 3/4" (44.5 mm) * 19" (482.6 mm) * 7 1/2" (190.5 mm)
Net Weight	± 2 kg
Shipping Weight	± 3 kg

BEHRINGER is constantly striving to maintain the highest professional standards. As a result of these efforts, modifications may be made from time to time to existing products without prior notice. Specifications and appearance may differ from those listed or shown.

## 7. WARRANTY

### § 1 WARRANTY CARD

To be protected by this warranty, the buyer must complete and return the enclosed warranty card (signed/stamped by retail dealer) within 14 days of the date of purchase to BEHRINGER INTERNATIONAL (address see § 3). Failure to return the card in due time (date as per postmark) will void any extended warranty claims.

### § 2 WARRANTY

1. BEHRINGER INTERNATIONAL warrants the mechanical and electronic components of this product to be free of defects in material and workmanship for a period of one (1) year from the original date of purchase, in accordance with the warranty regulations described below. If any defects occur within the specified warranty period that are not caused by normal wear or inappropriate use, BEHRINGER INTERNATIONAL shall, at its sole discretion, either repair or replace the product.

2. If the warranty claim proves to be justified, the product will be returned freight prepaid by BEHRINGER INTERNATIONAL within Germany. Outside of Germany, the product will be returned at the buyer's expense.

3. Warranty claims other than those indicated above are expressly excluded.

### § 3 RETURN AUTHORIZATION NUMBER

1. To obtain warranty service, the buyer must call BEHRINGER INTERNATIONAL during normal business hours BEFORE returning the product (Tel.: +49 (0) 21 54 / 92 06 66). All inquiries must be accompanied by a description of the problem. BEHRINGER INTERNATIONAL will then issue a return authorization number.

2. The product must be returned in its original shipping carton, together with the return authorization number, to the following address:

**BEHRINGER INTERNATIONAL GmbH  
Service Department**

**Hanns-Martin-Schleyer-Str. 36-38**

**D - 47877 Willich-Münchheide**

3. Shipments without freight prepaid will not be accepted.

### § 4 WARRANTY REGULATIONS

1. Warranty services will be furnished only if the product is accompanied by an original retail dealer's invoice. Any product deemed eligible for repair or replacement by BEHRINGER INTERNATIONAL under the terms of this warranty will be repaired or replaced within 30 days of receipt of the product at BEHRINGER INTERNATIONAL.

2. If the product needs to be modified or adapted in order to comply with applicable technical or safety standards on a national or local level, in any country which is not the country for which the product was originally developed and manufactured,

this modification/adaptation shall not be considered a defect in materials or workmanship. The warranty does not cover any such modification/adaptation, irrespective of whether it was carried out properly or not. Under the terms of this warranty, BEHRINGER INTERNATIONAL shall not be held responsible for any cost resulting from such a modification/adaptation.

3. Free inspections, maintenance/repair work and replacement of parts are expressly excluded from this warranty, in particular if caused by inappropriate use. Likewise, the warranty does not cover defects of expendable parts caused by normal wear of the product. Expendable parts are typically faders, potentiometers, switches and similar components.

4. Damages/defects caused by the following conditions are not covered by this warranty:

- ▲ misuse, neglect or failure to operate the unit in compliance with the instructions given in the user or service manuals.
- ▲ connection or operation of the unit in any way that does not comply with the technical or safety regulations applicable in the country where the product is used.
- ▲ damages/defects that are caused by force majeure or by any other condition beyond the control of BEHRINGER INTERNATIONAL.

5. Any repair carried out by unauthorized personnel will void the warranty.

6. Products which do not meet the terms of this warranty will be repaired exclusively at the buyer's expense. BEHRINGER INTERNATIONAL will inform the buyer of any such circumstance. If the buyer fails to submit a written repair order within 4 weeks after notification, BEHRINGER INTERNATIONAL will return the unit C.O.D. with a separate invoice for freight and packing. Such cost will also be invoiced separately when the buyer has sent in a written repair order.

### § 5 WARRANTY TRANSFERABILITY

This warranty is extended exclusively to the original buyer (customer of retail dealer) and is not transferable to anyone who may subsequently purchase this product. No other person (retail dealer, etc.) shall be entitled to give any warranty promise on behalf of BEHRINGER INTERNATIONAL.

### § 6 CLAIM FOR DAMAGES

Failure of BEHRINGER INTERNATIONAL to provide proper warranty service shall not entitle the buyer to claim (consequential) damages. In no event shall the liability of BEHRINGER INTERNATIONAL exceed the invoiced value of the product.

### § 7 OTHER WARRANTY RIGHTS

This warranty does not exclude or limit the buyer's statutory rights provided by national law, in particular, any such rights against the seller that arise from a legally effective purchase contract.

---

The information contained in this manual is subject to change without notice. No part of this manual may be reproduced or transmitted in any form or by any means, electronic or mechanical, including photocopying and recording of any kind, for any purpose, without the express written permission of BEHRINGER GmbH.

BEHRINGER and VIRTUALIZER are registered trademarks. ALL RIGHTS RESERVED © 1998 BEHRINGER.  
BEHRINGER INTERNATIONAL GmbH, Hanns-Martin-Schleyer-Str. 36-38, D-47877 Willich-Münchheide II

Tel. +49 (0) 21 54 / 92 06-0, Fax +49 (0) 21 54 / 92 06-30

