

Compact Disc Player

Operating Instructions



***CDP-XE500
CDP-XE400***

WARNING

To prevent fire or shock hazard, do not expose the unit to rain or moisture.

To avoid electrical shock, do not open the cabinet. Refer servicing to qualified personnel only.

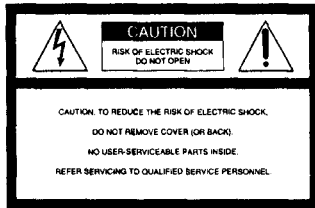

This symbol is intended to alert the user to the presence of uninsulated "dangerous voltage" within the product's enclosure that may be of sufficient magnitude to constitute a risk of electric shock to persons.



This symbol is intended to alert the user to the presence of important operating and maintenance (servicing) instructions in the literature accompanying the appliance.

INFORMATION

This equipment has been tested and found to comply with the limits for a Class B digital device, pursuant to Part 15 of the FCC Rules. These limits are designed to provide reasonable protection against harmful interference in a residential installation. This equipment generates, uses, and can radiate radio frequency energy and, if not installed and used in accordance with the instructions, may cause harmful interference to radio communications. However, there is no guarantee that interference will not occur in a particular installation. If this equipment does cause harmful interference to radio or television reception, which can be determined by turning the equipment off and on, the user is encouraged to try to correct the interference by one or more of the following measures:

- Reorient or relocate the receiving antenna.
- Increase the separation between the equipment and receiver.
- Connect the equipment into an outlet on a circuit different from that to which the receiver is connected.
- Consult the dealer or an experienced radio/TV technician for help.

CAUTION

You are cautioned that any changes or modification not expressly approved in this manual could void your authority to operate this equipment.

Owner's Record

The model and serial numbers are located at the rear of the unit. Record the serial number in the space provided below. Refer to them whenever you call upon your Sony dealer regarding this product.

Model No. _____

Serial No. _____

Precautions

On safety

- Caution — The use of optical instruments with this product will increase eye hazard.
- Should any solid object or liquid fall into the cabinet, unplug the player and have it checked by qualified personnel before operating it any further.

On power sources

- Before operating the player, check that the operating voltage of the player is identical with your local power supply. The operating voltage is indicated on the nameplate at the rear of the player.
- The player is not disconnected from the AC power source (mains) as long as it is connected to the wall outlet, even if the player itself has been turned off.
- If you are not going to use the player for a long time, be sure to disconnect the player from the wall outlet. To disconnect the AC power cord (mains lead), grasp the plug itself; never pull the cord.

- AC power cord must be changed only at the qualified service shop.

On placement

- Place the player in a location with adequate ventilation to prevent heat build-up in the player.
- Do not place the player on a soft surface such as a rug that might block the ventilation holes on the bottom.
- Do not place the player in a location near heat sources, or in a place subject to direct sunlight, excessive dust or mechanical shock.

On operation

- If the player is brought directly from a cold to a warm location, or is placed in a very damp room, moisture may condense on the lenses inside the player. Should this occur, the player may not operate properly. In this case, remove the disc and leave the player turned on for about an hour until the moisture evaporates.

On adjusting volume

- Do not turn up the volume while listening to a portion with very low level inputs or no audio signals. If you do, the speakers may be damaged when a peak level portion is played.

On cleaning

- Clean the cabinet, panel and controls with a soft cloth slightly moistened with a mild detergent solution. Do not use any type of abrasive pad, scouring powder or solvent such as alcohol or benzene.

If you have any questions or problems concerning your player, please consult your nearest Sony dealer.

Welcome!

Thank you for purchasing the Sony Compact Disc Player. Before operating the unit, please read this manual thoroughly and retain it for future reference.

About This Manual

The instructions in this manual are for models CDP-XE500 and CDP-XE400. The CDP-XE500 is the model used for illustration purposes. Any difference in operation is clearly indicated in the text, for example, "CDP-XE500 only."

Conventions

- Instructions in this manual describe the controls on the player. You can also use the controls on the remote if they have the same or similar names as those on the player. In the instructions, the buttons on the remote are indicated in parentheses.
- The following icons are used in this manual:



Indicates that you can do the task using the remote. (Note that the CDP-XE400 cannot do the tasks marked with this icon.)



Indicates hints and tips for making the task easier.

TABLE OF CONTENTS

Getting Started

Unpacking	4
Hooking Up the System	4

Playing a CD	6
--------------------	---

Playing CDs

Using the Display	7
Locating a Specific Track or a Particular Point in a Track	8
Playing Tracks Repeatedly	8
Playing in Random Order (Shuffle Play)	9
Creating Your Own Program (Program Play)	9

Recording From CDs

Recording Your Own Program	11
Recording a CD by Specifying Tape Length (Time Edit)	12
Fading In or Out	13
Adjusting the Recording Level (Peak Search)	14

Additional Information

Notes on CDs	14
Troubleshooting	15
Specifications	15

Index

Index	Backcover
-------------	-----------

Unpacking

Check that you received the following items:

- Audio connecting cord (1)
- Remote commander (remote) (CDP-XE500 only) (1)
- Sony SUM-3 (NS) batteries (CDP-XE500 only) (2)

Inserting batteries into the remote (CDP-XE500 only)

You can control the player using the supplied remote. Insert two size AA (R6) batteries by matching the + and - on the batteries. When using the remote, point it at the remote sensor  on the player.

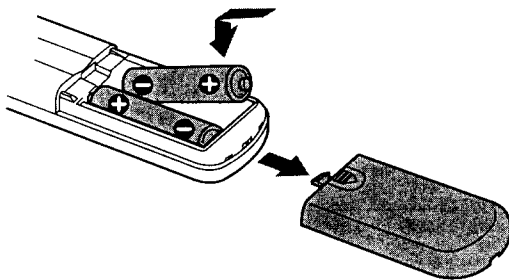

When to replace batteries

With normal use, the batteries should last for about six months. When the remote no longer operates the player, replace all the batteries with new ones.

Notes

- Do not leave the remote near an extremely hot or humid place.
- Do not drop any foreign object into the remote casing, particularly when replacing the batteries.
- Do not expose the remote sensor to direct sunlight or lighting apparatuses. Doing so may cause a malfunction.
- If you don't use the remote for an extended period of time, remove the batteries to avoid possible damage from battery leakage and corrosion.

Hooking Up the System

Overview

This section describes how to hook up the CD player to an amplifier. Be sure to turn off the power of each component before making the connections.

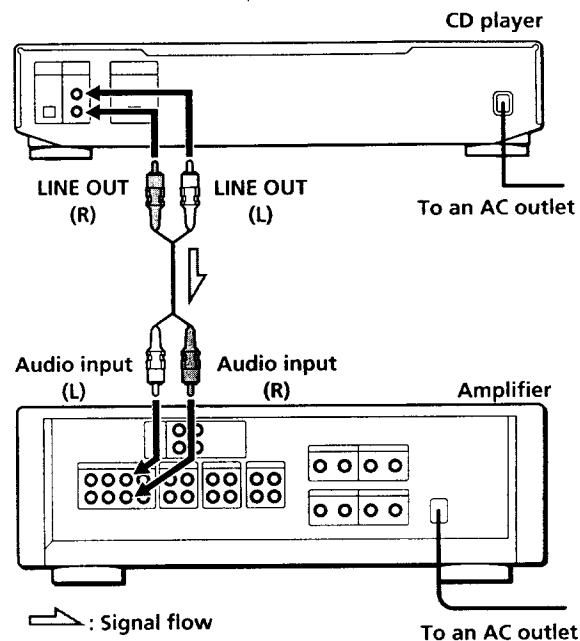

What cords will I need?

Audio cord (supplied) (1)



Hookups

When connecting an audio cord, be sure to match the color-coded cord to the appropriate jacks on the components: Red (right) to Red and White (left) to White. Be sure to make connections firmly to avoid hum and noise.

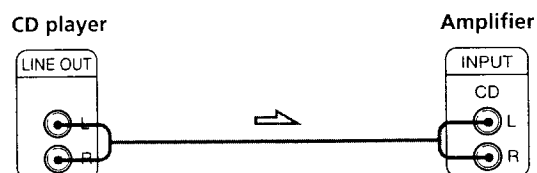

💡 You can adjust the output level to the amplifier (CDP-XE500 only)

Press LINE OUT LEVEL +/- on the remote. You can reduce the output level up to -20 dB.

When you reduce the output level, **FADE** appears in the display.

When you turn off the player, the output level automatically returns to the maximum level.

• **If you have a digital component such as a digital amplifier, D/A converter, DAT or MD (CDP-XE500 only)**

Connect the component via the DIGITAL OUT (OPTICAL) connector using the optical cable (not supplied). Take off the cap and plug in the optical cable.

Note that you cannot use fading in or out (page 13) and Time Fade (page 13) functions when making this connection.

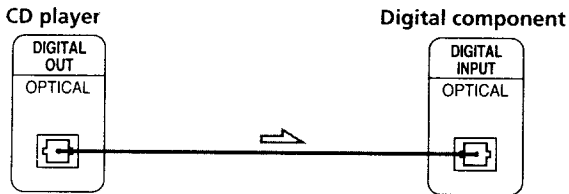
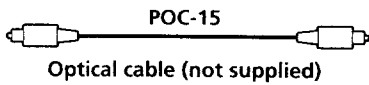

Note

When you connect via the DIGITAL OUT (OPTICAL) connector, noise may occur when you play CD software other than music, such as a CD-ROM.

Connecting the AC power cord

Connect the AC power cord to a wall outlet.

Where do I go next?

Now you're ready to use your player.

If you aren't familiar with how to play CDs, go to the section "Playing a CD" on page 6.

Then, go to the following sections for other operations.

Playing a CD

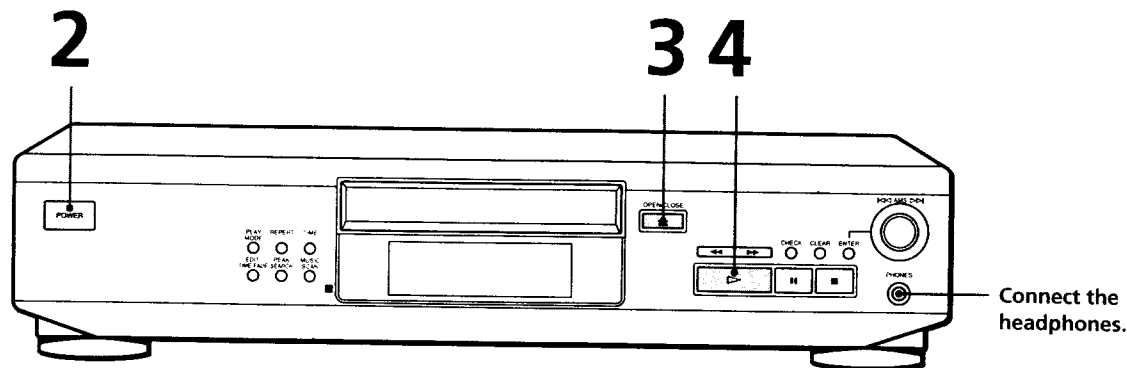

• See pages 4 – 5 for the hookup information.

💡 If you turn on the player with a CD in the tray
 You can start playing automatically from the beginning of the CD. If you connect a commercially available timer, you can start playing the CD at any time you want.

💡 You can adjust the output level with the LINE OUT LEVEL +/- on the remote (CDP-XE500 only) **⏏**

💡 You can adjust the headphones volume on the remote (CDP-XE500 only) **⏏**.
 Connect the headphones to the PHONES jack and adjust the volume with the LINE OUT LEVEL +/- on the remote.

1 Turn on the amplifier and select the CD player position so that you can listen to the sound from this player.

2 Press POWER to turn on the player.

3 Press **⏏** OPEN/CLOSE, and place a disc on the disc tray.

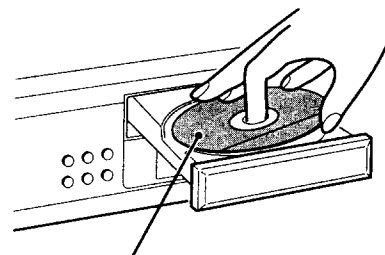

With the label side up

4 Press **▶**.
 The disc tray closes and the player plays all the tracks once (Continuous Play).

Adjust the volume on the amplifier.

To stop playback

Press **■**.

To	You need to
Pause	Press ⏏
Resume play after pause	Press ⏏ or ▶
Go to the next track	Turn ⏏ AMS ▶▶ clockwise
Go back to the preceding track	Turn ⏏ AMS ◀◀ counterclockwise
Stop play and remove the CD	Press ⏏ OPEN/CLOSE

Using the Display

You can check information about the disc using the display.

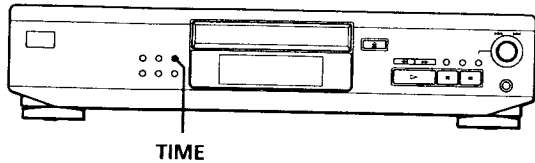

Display information while playing a disc

While playing a disc, the display shows the current track number, playing time and the music calendar.

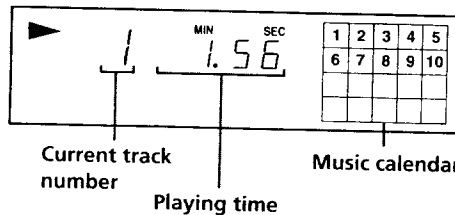

Checking the total number and playing time of the tracks

Press TIME before you start playing. The display shows the total number of tracks, total playing time and music calendar.

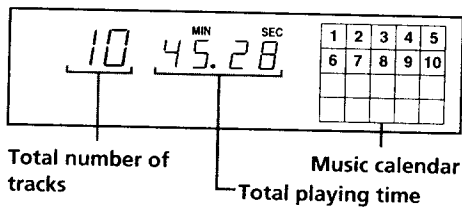

The track numbers in the music calendar disappear after they are played.

Checking the remaining time

Each time you press TIME while playing a disc, the display changes as shown in the chart below.

Playing time and number of the current track

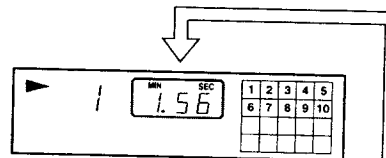

Press

Remaining time on the current track

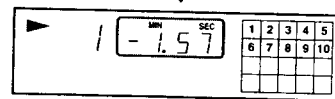

If the track number exceeds 68, "----" appears instead of the remaining time.

Press

Remaining time on the disc

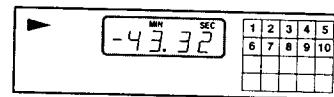

If the remaining time exceeds 100 minutes in Program Play mode, "----" appears instead of the remaining time.

Press

Locating a Specific Track or a Particular Point in a Track

You can quickly locate any track while playing a disc using the AMS (Automatic Music Sensor) on the player or number buttons on the remote.

You can also locate a particular point in a track while playing a disc.

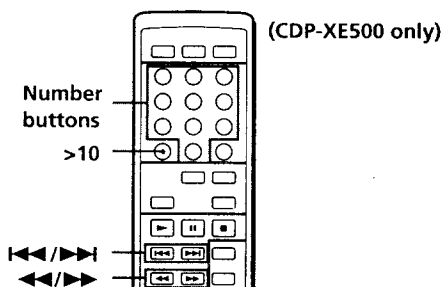
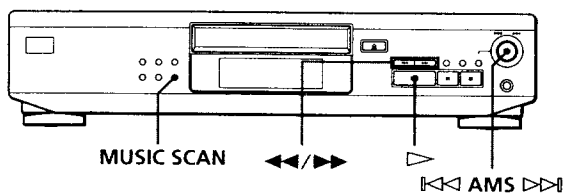

To locate	You need to
The next or succeeding tracks	Turn AMS clockwise until you find the track. When using the remote, press >>> repeatedly until you find the track.
The current or preceding tracks	Turn AMS counterclockwise until you find the track. When using the remote, press <<< repeatedly until you find the track.
A specific track directly	Turn AMS until you find the track number you want appears in the display. When using the remote, press number button of the track.
By scanning each track for 10 seconds (Music Scan)	Press MUSIC SCAN . When you find the track you want, press > to start playing the track.
A point while monitoring the sound	>>> (forward) or <<< (backward) and hold down until you find the point
A point quickly by observing the display during pause	>>> (forward) or <<< (backward) and hold down until you find the point. You will not hear the sound during the operation.

When you directly locate a track numbered over 10 when using the remote (CDP-XE500 only)

Press >10 first, then the corresponding number buttons. To enter "0," use button 10.

Example: To play track number 30
Press >10 first, then 3 and 10.

You can extend the playing time during Music Scan

Press **MUSIC SCAN** repeatedly until the playing time you want (10, 20 or 30) appears in the display. Each time you press the button, the playing time changes cyclically.

Note

If "7 7" appears in the display, the disc has reached the end while you were pressing **>>>**. Press **<<<** or turn **AMS** counterclockwise to go back.

Playing Tracks Repeatedly

You can play tracks repeatedly in any play mode.

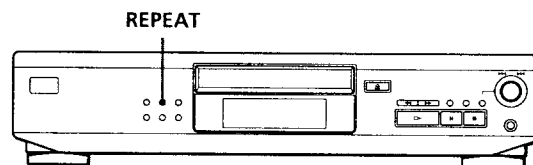

Press **REPEAT** while playing a disc. "REPEAT" appears in the display. The player repeats the tracks as follows:

When the disc is played in	The player repeats
Continuous Play (page 6)	All the tracks
Shuffle Play (page 9)	All the tracks in random orders
Program Play (page 9)	The same program

To cancel Repeat Play

Press **REPEAT** repeatedly until "REPEAT" disappears from the display.

Repeating the current track

You can repeat only the current track in any playmode.

While the track you want is being played, press **REPEAT** repeatedly until "REPEAT 1" appears in the display.

Playing in Random Order (Shuffle Play)

You can have the player "shuffle" tracks and play in a random order.

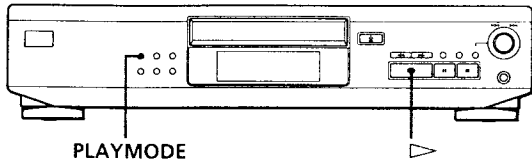

- 1 Press PLAYMODE repeatedly until "SHUFFLE" appears in the display. When using the remote, press SHUFFLE.
- 2 Press ▷ to start Shuffle Play. The [] indication appears while the player is "shuffling" the tracks.

To cancel Shuffle Play

Press PLAYMODE twice. When using the remote, press CONTINUE (CDP-XE500 only).

💡 You can start Shuffle Play while playing

Press PLAYMODE repeatedly until "SHUFFLE" appears in the display. When using the remote, press SHUFFLE (CDP-XE500 only). Shuffle Play starts from the current track.

Creating Your Own Program (Program Play)

You can arrange the order of the tracks on a disc and create your own program. The program can contain up to 24 tracks.

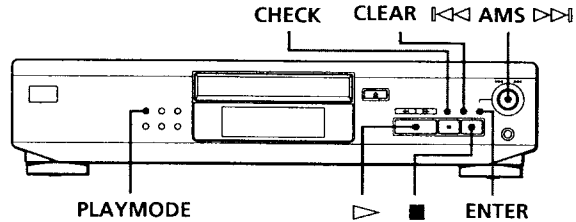

Creating a program on the player

- 1 Press PLAYMODE repeatedly until "PROGRAM" appears in the display before you start playing.
- 2 Turn ◀◀ AMS ▶▶ until the track number you want appears in the display. The total playing time and the track numbers being programmed are flashing in the display.

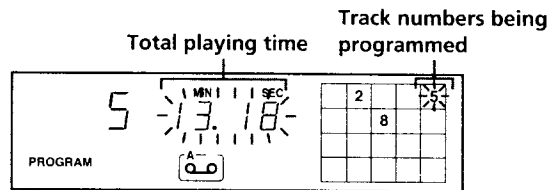

- 3 Press ENTER to select the track.

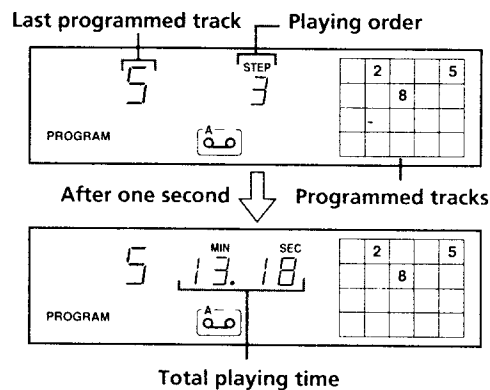

If you've made a mistake

Press CLEAR, then repeat Steps 2 and 3.

(Continued)

- Repeat Steps 2 and 3 to program the tracks in the order you want.
- Press \triangleright to start Program Play.

To cancel Program Play

Press PLAYMODE.

- When tracks, which aren't numerically consecutive on the disc, are programmed consecutively (i.e. 1, 3, 5 etc.)

A one-second access time blank is added between the tracks.

- The program remains even after the Program Play ends

When you press \triangleright , you can play the same program again.

Notes

- The total playing time doesn't appear in the display when it exceeds 100 minutes.
- "FULL" appears in the display when you try to add a track to a program which already contains 24 tracks.

Creating a program using the remote (CDP-XE500 only)

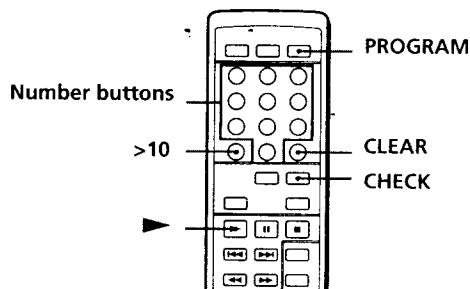

- Press PROGRAM before you start playing. "PROGRAM" appears in the display.

- Press number buttons of the tracks you want to program in the order you want.
Example: To program the tracks 2, 8 and 5.
Press number buttons in the order 2, 8 and 5.

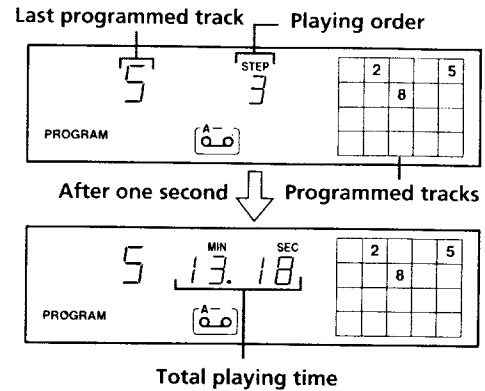

To select a track with a number over 10

Use >10 button (see page 8).

If you've made a mistake

Press CLEAR, then press the correct track number.

- Press \blacktriangleright to start Program Play.

To cancel Program Play

Press CONTINUE.

- When tracks, which aren't numerically consecutive on the disc, are programmed consecutively (i.e. 1, 3, 5 etc.)

A one-second access time blank is added between the tracks.

- The program remains even after the Program Play ends

When you press \blacktriangleright , you can play the same program again.

- You can check the total playing time while programming using the remote (Program Edit)

To select a track, press \blacktriangleleft or \blacktriangleright and check the total playing time. Then press PROGRAM to confirm your selection.

Notes

- The total playing time doesn't appear in the display when it exceeds 100 minutes.
- "FULL" appears in the display when you try to add a track to a program which already contains 24 tracks.

Checking the track order

You can check your program before or after you start playing.

Press CHECK.

Each time you press this button, the display shows the track number in the programmed order. After the last track in the program, the display shows "End" and returns to the original display. If you check the order after you start playing, the display shows only the remaining track numbers.

Changing the track order

You can change your program before you start playing.

To	You need to
Erase a track	Press CHECK until the track you don't want appears in the display, then press CLEAR
Erase the last track in the program	Press CLEAR. Each time you press the button, the last track will be cleared.
Add tracks to the end of the program	Turn ◀◀ AMS ▶▶ until track number you want to add appears, then press ENTER. When using the remote, press the number button of the tracks to be added.
Change the whole program completely	Press ■ (stop). Create a new program following the programming procedure.

Recording Your Own Program

You can record the program you've created on a tape, DAT or MD. The program can contain up to 24 tracks. By inserting a pause during programming, you can divide the program into two for recording on both sides of a tape.

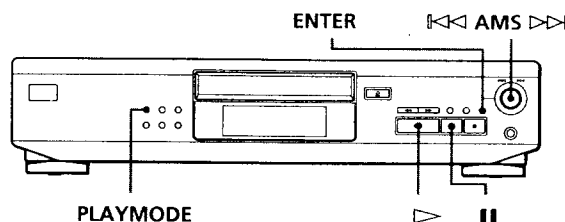

- 1 Create your program (for side A when recording on a tape) while checking the total playing time indicated in the display.
Follow Steps 1 to 4 in "Creating a program on the player" on page 9 or Steps 1 and 2 in "Creating a program using the remote" on page 10.
The [0.00] indication appears in the display.
 - 2 When you record on both sides of the tape, press ■ to insert a pause.
The "P" and [0.00] indications appear in the display and the playing time is reset to "0.00."
When you record on one side of the tape or on a DAT or MD, skip this step and go to Step 4.
- A pause is counted as one track**
You can program up to 23 tracks when you insert a pause.
- 3 Repeat Step 1 to create the program for side B.
 - 4 Start recording on the deck and then press ▷ on the player.
When you record on both sides of the tape, the player pauses at the end of the program for side A.
 - 5 When you record on side B, reverse the tape and press ▷ or ■ on the player to resume playing.

💡 To check and change your program
See the left column of this page.
The [0.00] indication appears while checking the program for side A and [0.00] while checking the program for side B.

💡 When tracks, which aren't numerically consecutive on the disc, are programmed consecutively (i.e. 1, 3, 5 etc.)
A one-second access time blank is added between the tracks.

Recording a CD by Specifying Tape Length (Time Edit)

You can have the player create a program that will fit the length of the tape.

The player automatically creates a program, keeping the original order of the disc.

The program can contain up to 24 tracks (a pause inserted between tracks is counted as one track).

Note that tracks whose numbers are over 24 cannot be programmed automatically.

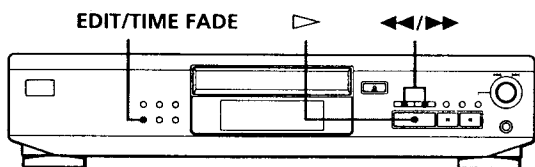

- 1 Press EDIT/TIME FADE before you start playing until EDIT appears and "A" in the  indication flashes in the display.
- 2 Press ◀ or ▶ to specify the tape length. Each time you press these buttons, the display changes as shown below, with the tape length of one side following each indication.

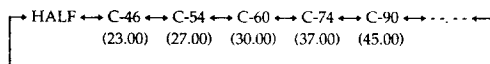

When you select "HALF"

The player sets the program of each side to a half of the total playing time of the disc. Note that you cannot select "HALF" when the disc has more than 24 tracks.

- 3 Press EDIT/TIME FADE to have the player create the program. The display shows the tracks to be recorded. "B" in the  indication flashes in the display.
- 4 When you record on both sides of the tape, press EDIT/TIME FADE again. The player inserts a pause, then creates the program for side B. The display shows the programmed tracks. When you record on one side of the tape or on a DAT or MD, skip this step.
- 5 Start recording on the deck and then press ▷ on the player. When you record on both sides of the tape, the player pauses at the end of the program for side A.
- 6 When you record on side B, reverse the tape and press ▷ or || on the player to resume playing.

To cancel Time Edit

Press PLAYMODE until "SHUFFLE" and "PROGRAM" disappear from the display.

When using the remote, press CONTINUE (CDP-XE500 only).

💡 You can program the tracks you want in advance

Select the tracks before doing the above procedure. The player creates a program from the remaining tracks. In this case, you cannot select "HALF" to specify the tape length.

💡 You can freely specify the tape length

Set the tape length using ◀◀AMS▶▶.

Example: When the tape length of one side is 30 minutes and 15 seconds

- 1 To set the minutes, turn ◀◀AMS▶▶ until "30" appears in the display, then press ENTER.
- 2 To set the seconds, turn ◀◀AMS▶▶ until "15" appears in the display, then press ENTER.

💡 When tracks, which aren't numerically consecutive on the disc, are programmed consecutively (i.e. 1, 3, 5 etc.)

A one-second access time blank is added between the tracks.

💡 To check and change your program

See page 11.



Fading In or Out

You can manually fade in or out to prevent tracks from starting or ending abruptly.

Note that you cannot use this effect when you use the DIGITAL OUT (OPTICAL) connector (for CDP-XE500).

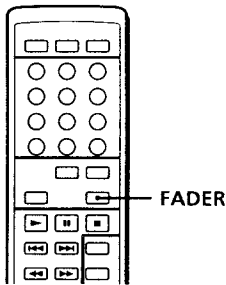
Fading in or out at the point you want (CDP-XE500 only)







To	Press FADER
Start play fading in	During pause. The  indication flashes and play fades in.
End play fading out	When you want to start fading out. The  indication flashes. The play fades out and the player pauses.

Fading time lasts for 5 seconds. If you press FADER during Music Scan (page 8), fading time changes to 2 seconds.

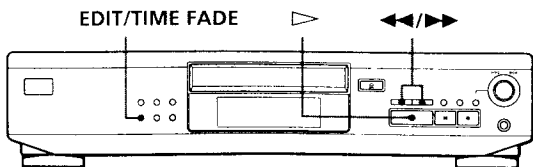
Fading out at the specified time (Time Fade)

You can have the player fade out automatically by specifying the playing time. Once you set the Time Fade, it works twice, that is, the play fades out at the end of both sides of a tape.





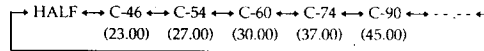

- 1 Press EDIT/TIME FADE repeatedly before you start playing until "" and "A" in the  indication appear in the display.
- 2 Press  or  to specify the playing time. Each time you press these buttons, the display changes as shown below, with the playing time of one side following each indication.



When you select "HALF"

The player sets the playing time to a half of the total playing time.

- 3 Press  to start playing. At the specified time the play fades out and the player pauses. "B" in the  indication appears in the display.
- 4 To record on side B, reverse the tape and press  or  on the player to resume playing. Again, the play fades out at the specified time.

To cancel Time Fade

Press EDIT/TIME FADE.

You can freely specify the playing time

See "You can freely specify the tape length" on page 12 .



You can change discs during Time Fade

If the play ends before the specified fade-out time, (for example, when you record CD-singles on a tape) change the disc. The specified fade-out time is counted only during playing.

You can fade in to resume playing in Step 4 (CDP-XE500 only)

After you reverse the tape, press FADER on the remote.

Note

Time Fade will be cancelled if you press  or  during the operation.

Adjusting the Recording Level (Peak Search)

The player locates the highest level among the tracks to be recorded to let you adjust the recording level before you start recording.

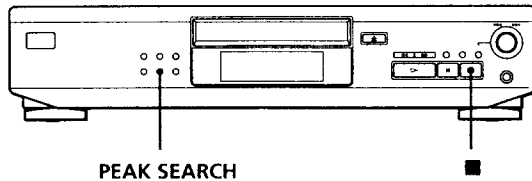

- 1 Before you start playing, press PEAK SEARCH. "PEAK" flashes in the display and the player repeats the portion of the highest level.
- 2 Adjust the recording level on the deck.
- 3 Press ■ on the player to stop Peak Search. "PEAK" disappears from the display.

Note

The portion with the highest level may differ every time you try the adjustment on the same disc. The difference is, however, so slight that you won't find any problem in adjusting the recording level precisely.

Notes on CDs

On handling CDs

- To keep the disc clean, handle the disc by its edge. Do not touch the surface.
- Do not stick paper or tape on the disc.

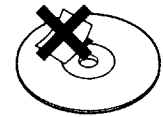

Not this way

- Do not expose the disc to direct sunlight or heat sources such as hot air ducts, nor leave it in a car parked in direct sunlight as there can be considerable rise in temperature inside the car.
- Do not use any commercially available stabilizer. If you do, the disc and the player may be damaged.
- After playing, store the disc in its case.

On cleaning

- Before playing, clean the disc with a cleaning cloth. Wipe the disc from the center out.

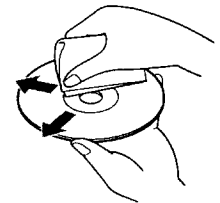

- Do not use solvents such as benzine, thinner, commercially available cleaners or anti-static spray intended for vinyl LPs.

Troubleshooting

If you experience any of the following difficulties while using the player, use this troubleshooting guide to help you remedy the problem. Should any problem persist, consult your nearest Sony dealer.

There's no sound.

- ➔ Check that the player is connected securely.
- ➔ Make sure you operate the amplifier correctly.
- ➔ Adjust the output level with LINE OUT LEVEL +/- on the remote (CDP-XE500 only).

The CD does not play.

- ➔ There's no CD inside the player ("no DISC" appears). Insert a CD.
- ➔ Place the CD with the label side up on the disc tray correctly.
- ➔ Clean the CD (see page 14).
- ➔ Moisture has condensed inside the player. Remove the disc and leave the player turned on for about an hour (see page 2).

The recording level has changed (CDP-XE500 only).

- ➔ The recording level changes if you adjust the output level with LINE OUT LEVEL +/- on the remote during recording.

The remote does not function (CDP-XE500 only).

- ➔ Remove the obstacles in the path of the remote and the player.
- ➔ Point the remote at the remote sensor  on the player.
- ➔ Replace all the batteries in the remote with new ones if they are weak.

Specifications

Compact disc player

Laser	Semiconductor laser ($\lambda = 780 \text{ nm}$) Emission duration: continuous
Laser output	Max 44.6 μW * * This output is the value measured at a distance of 200 mm from the objective lens surface on the Optical Pick-up block with 7 mm aperture.
Frequency response	2 Hz to 20 kHz $\pm 0.5 \text{ dB}$
Signal-to-noise ratio	More than 100 dB
Dynamic range	More than 98 dB
Harmonic distortion	Less than 0.0045%
Channel separation	More than 95 dB

Outputs

	Jack type	Maximum output level	Load impedance
LINE OUT	Phono jacks	2 V (at 50 kilohms)	Over 10 kilohms
DIGITAL OUT (OPTICAL) (CDP-XE500 only)	Optical output connector	-18 dBm	Wave length: 660 nm
PHONES	Stereo phone jack	10 mW	32 ohms

General

Power requirements	120 V AC, 60 Hz
Power consumption	10 W
Dimensions (approx.) (w/h/d)	430 x 95 x 295 mm (17 x 3 3/4 x 11 5/8 in.) incl. projecting parts
Mass (approx.)	3.0 kg (6 lbs 10 oz)

Supplied accessories

- Audio cord (2 phono plugs - 2 phono plugs) (1)
- Remote commander (remote) (CDP-XE500 only) (1)
- Sony SUM-3 (NS) batteries (CDP-XE500 only) (2)

Design and specifications are subject to change without notice.

Index

A, B

AMS 8
Automatic Music Sensor. *See*
AMS

C, D

Connecting 4
Continuous Play 6

E

Editing. *See* Recording

F, G

Fading 13
Time Fade 13

H, I, J, K

Half disc (HALF) 12
Handling CDs 15
Hookups 4
overview 4

L

Locating
by monitoring 8
by observing the display 8
by scanning 8
directly 8
using AMS 8

M, N, O

Music Scan 8

P, Q

Peak Search 14
Playback
Continuous Play 6
Program Play 9
Repeat Play 8
Shuffle Play 9
Program 9
changing 11
checking 11
for recording 12
Program Edit 11

R

Recording 11
a program 11
using Time Edit 12
Remaining time 7
Remote control 4
Repeating
all 8
the current track 9

S

Scanning. *See* Music Scan
Searching. *See* Locating
Shuffle Play 9

T

Time Edit 12
Time Fade 13
Total playing time 7
Troubleshooting 15

U, V, W, X, Y, Z

Unpacking 4

Names of controls

Buttons

CHECK 11
CLEAR 11
CONTINUE 6
EDIT/TIME FADE 12
FADER 13
LINE OUT LEVEL +/- 6
MUSIC SCAN 8
≡ OPEN/CLOSE 6
PEAK SEARCH 14
PLAYMODE 9
PROGRAM 9
REPEAT 8
SHUFFLE 9
TIME 7
▷ 6
|| 6
■ 6
◀◀/▶▶ 8
◀◀/▶▶ 8
>10 8
Number 8

Switch

POWER 6

Connector

DIGITAL OUT (OPTICAL) 5

Jacks

PHONES 6
LINE OUT 5

Others

Disc tray 6
Display 7
◀◀ AMS ▶▶ 6
■ 4